

1: 10,4* ←	Serie: 46,0
2: 10,0 ↓	
3: 9,6 ↘	
4: 8,0 ↓	
5: 9,1 ↙	
Summa: 46,0	

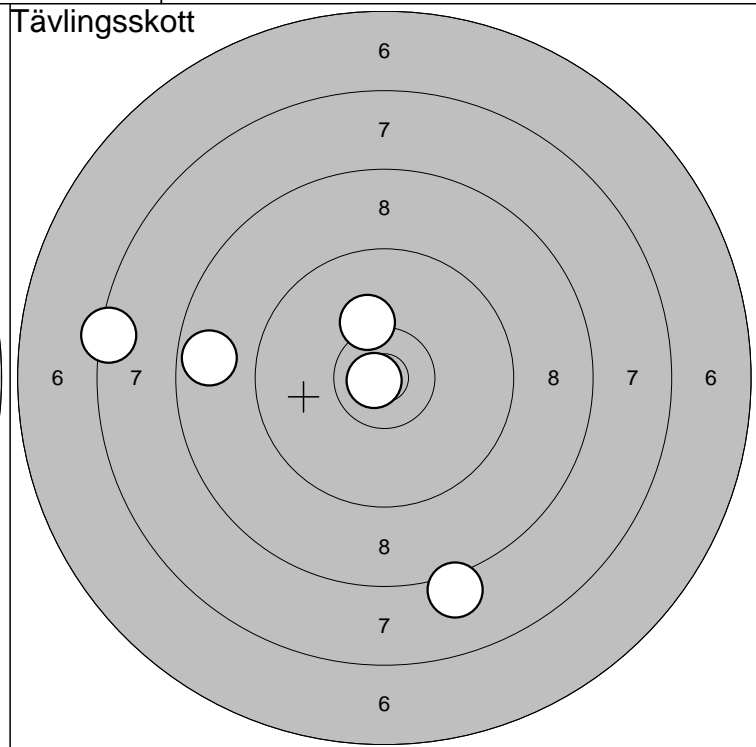

6: 10,2 ↑	Serie: 43,0
7: 10,8* ←	
8: 8,1 ↓	
9: 7,4 ←	
10: 8,7 ←	
Summa: 89,0	

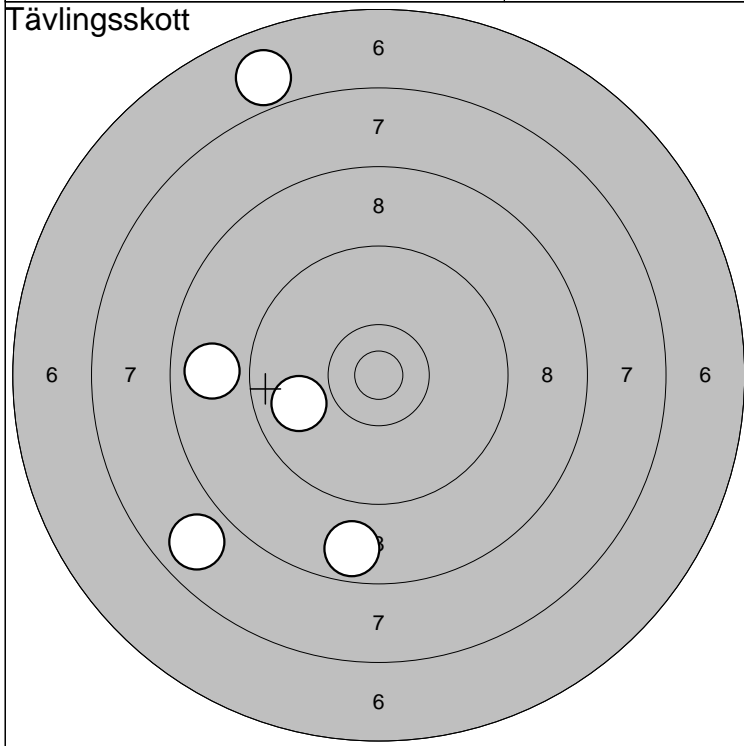

11: 8,7 ↓	Serie: 38,0
12: 9,9 ←	
13: 7,8 ↙	
14: 8,8 ←	
15: 6,9 ↑	
Summa: 127,0	

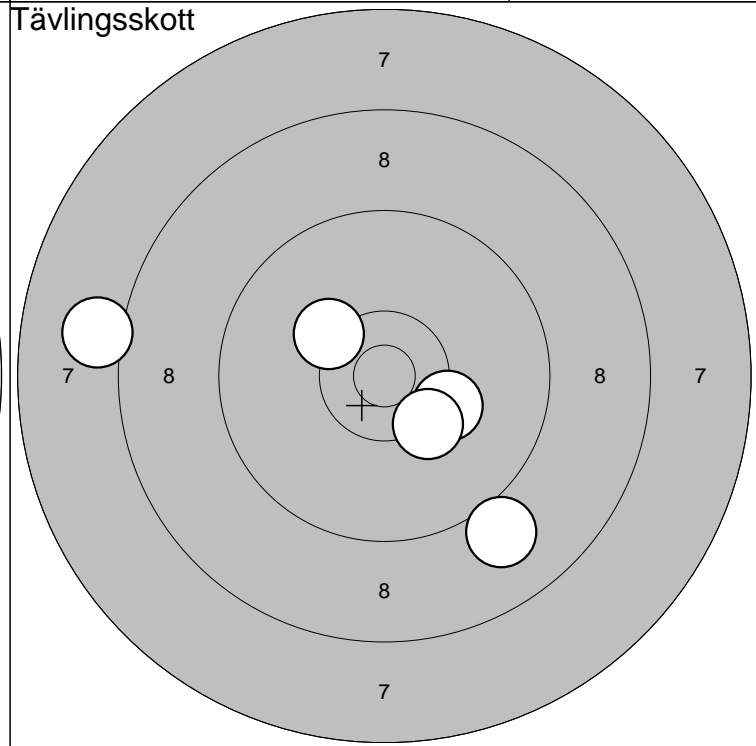

16: 8,1 ←	Serie: 47,0
17: 9,0 ↓	
18: 10,2 ↘	
19: 10,3* ↓	
20: 10,3 ↗	
Summa: 174,0	

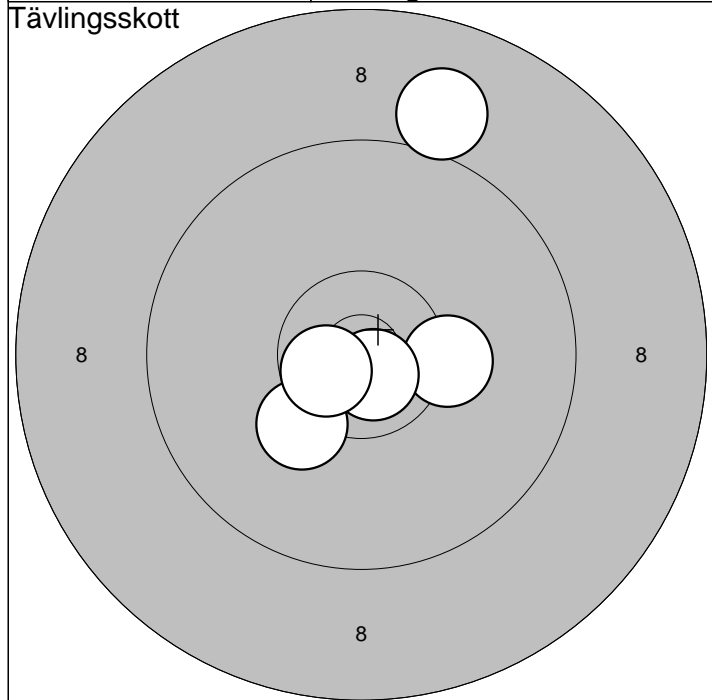

1:10,2 ↙	Serie: 49,0
2:10,3 →	
3:10,8* ↘	Summa: 49,0
4: 9,0 ↗	
5:10,7* ↖	

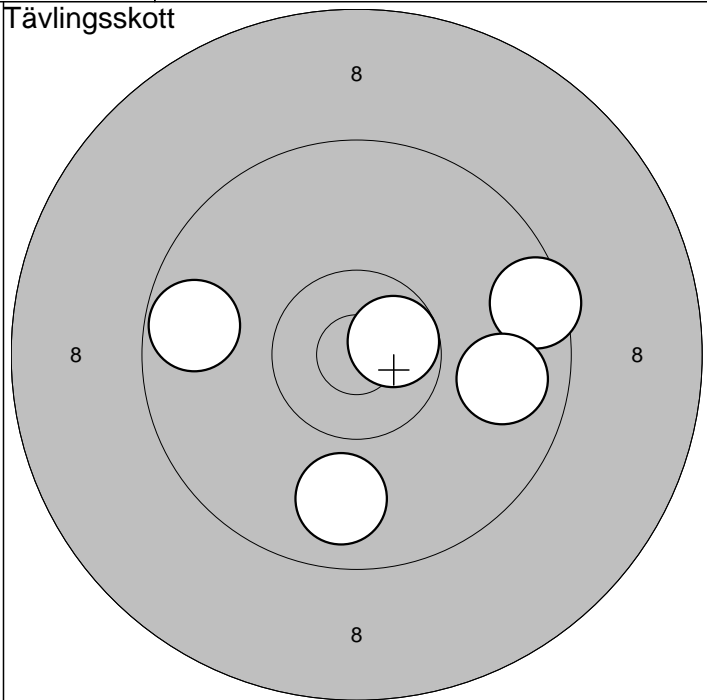

6: 9,5 →	Serie: 46,0
7: 9,8 ↓	
8: 9,7 ←	Summa: 95,0
9:10,6* →	
10: 9,8 →	

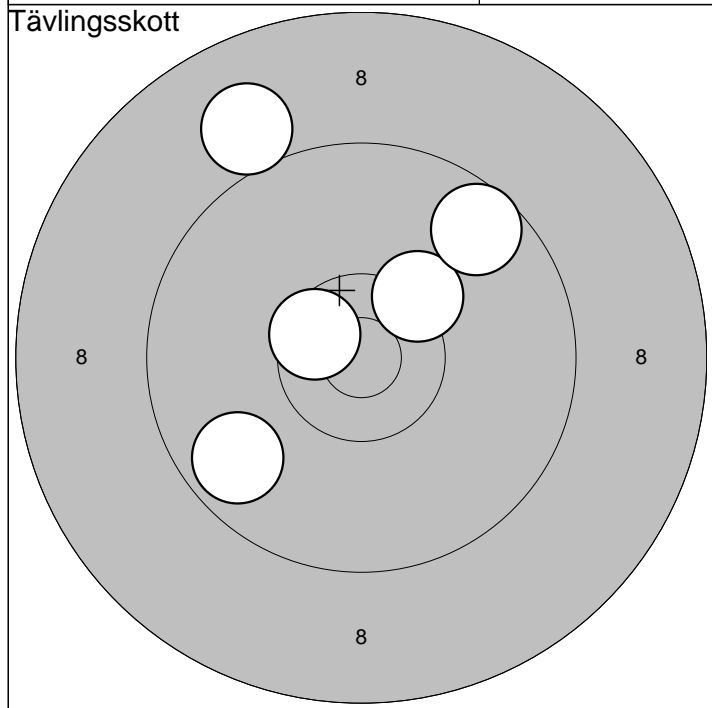

11:10,3* ↗	Serie: 47,0
12: 9,6 ↗	
13: 9,7 ↖	Summa: 142,0
14: 9,0 ↗	
15:10,6* ↖	

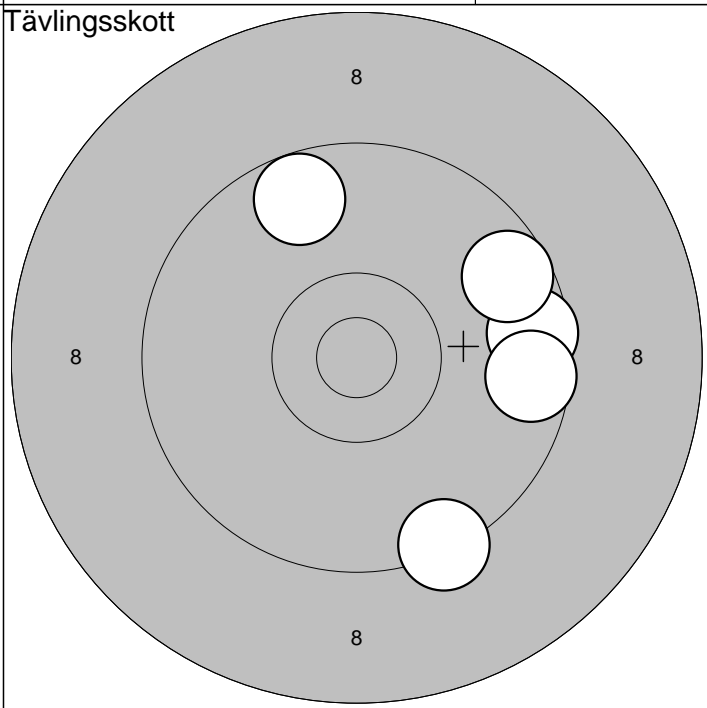

16: 9,4 ↓	Serie: 45,0
17: 9,6 →	
18: 9,7 ↗	Summa: 187,0
19: 9,6 →	
20: 9,6 →	

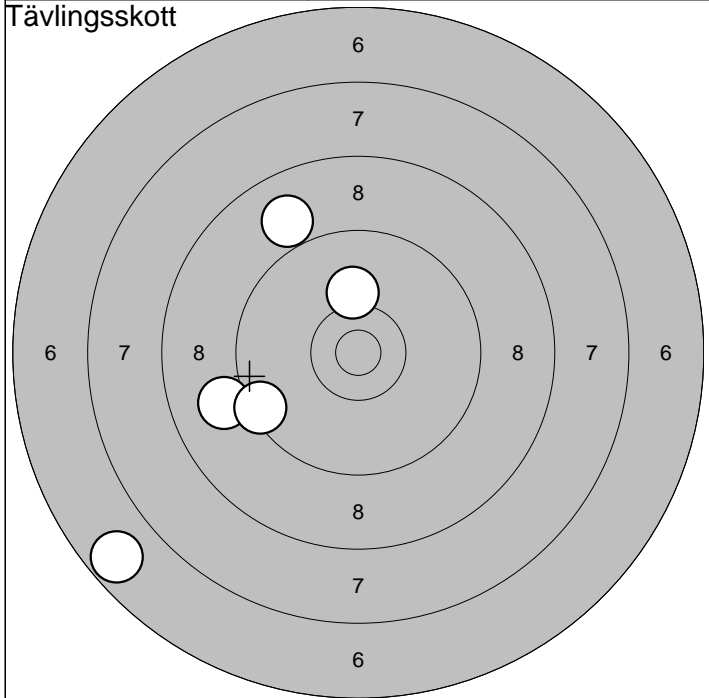

1: 9,0 ←	Serie: 42,0
2: 9,4 ←	
3: 10,1 ↑	Summa: 42,0
4: 8,9 ↗	
5: 6,7 ↙	

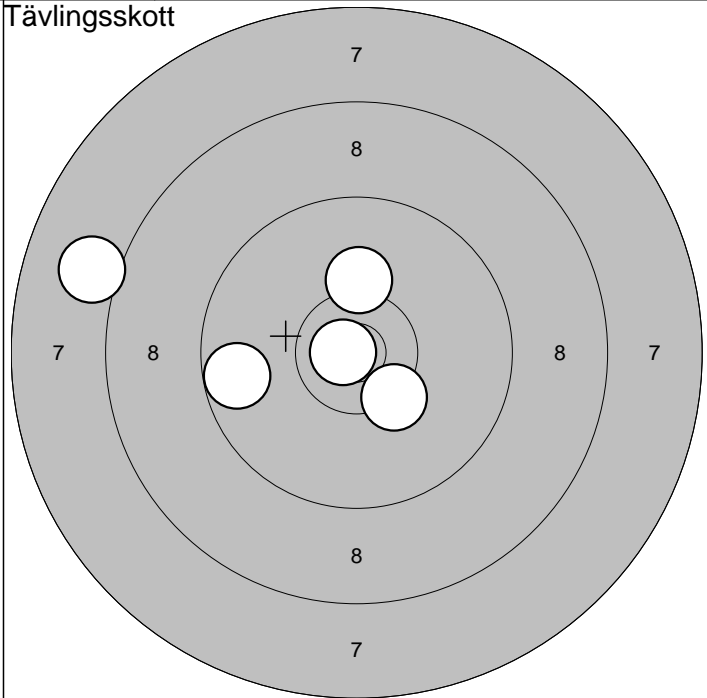

6: 8,0 ←	Serie: 47,0
7: 10,3* ↘	
8: 9,7 ←	Summa: 89,0
9: 10,8* ←	
10: 10,2 ↑	

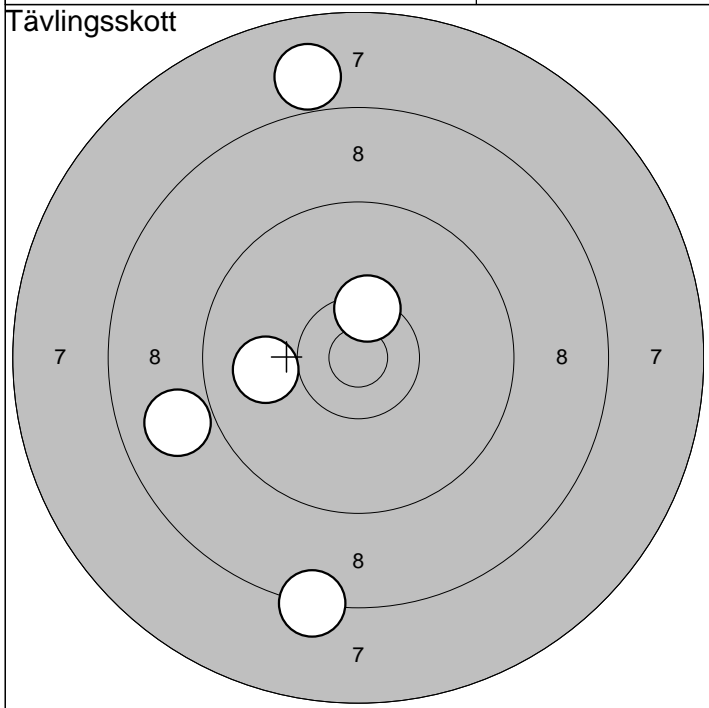

11: 10,0 ←	Serie: 43,0
12: 10,4* ↑	
13: 8,9 ←	Summa: 132,0
14: 7,9 ↑	
15: 8,3 ↓	

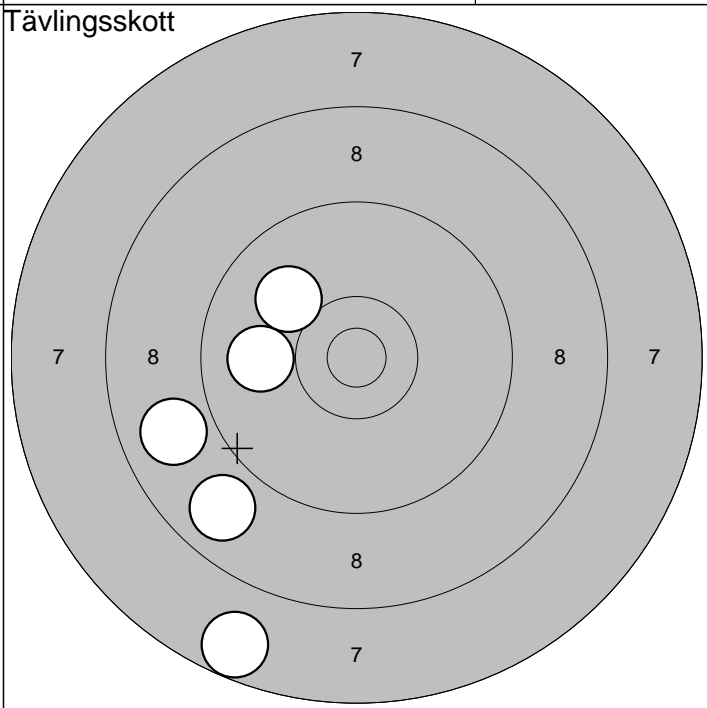

16: 8,8 ↘	Serie: 42,0
17: 8,9 ←	
18: 9,9 ←	Summa: 174,0
19: 7,7 ↘	
20: 10,0 ↙	

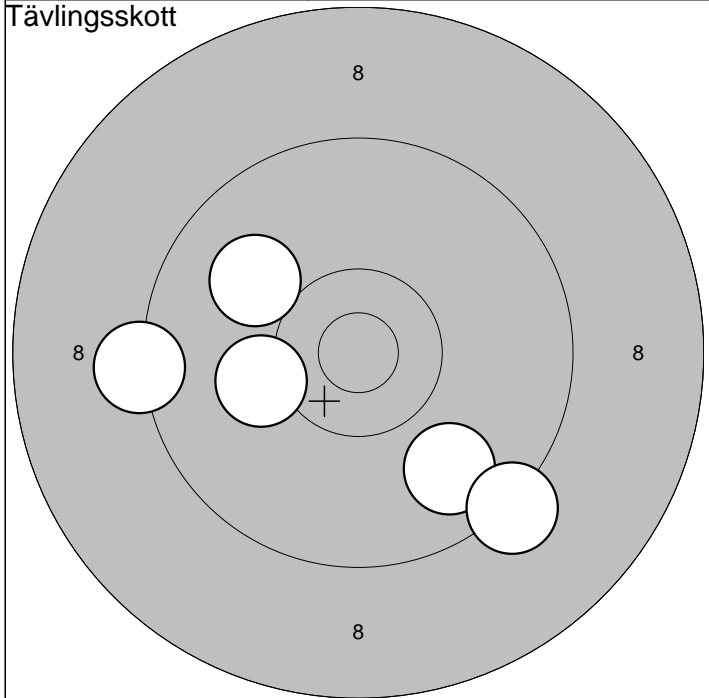

1: 9,8 ↘
2: 9,3 ↘
3: 9,3 ←
4:10,2 ←
5:10,0 ↗

Serie: 47,0
Summa: 47,0

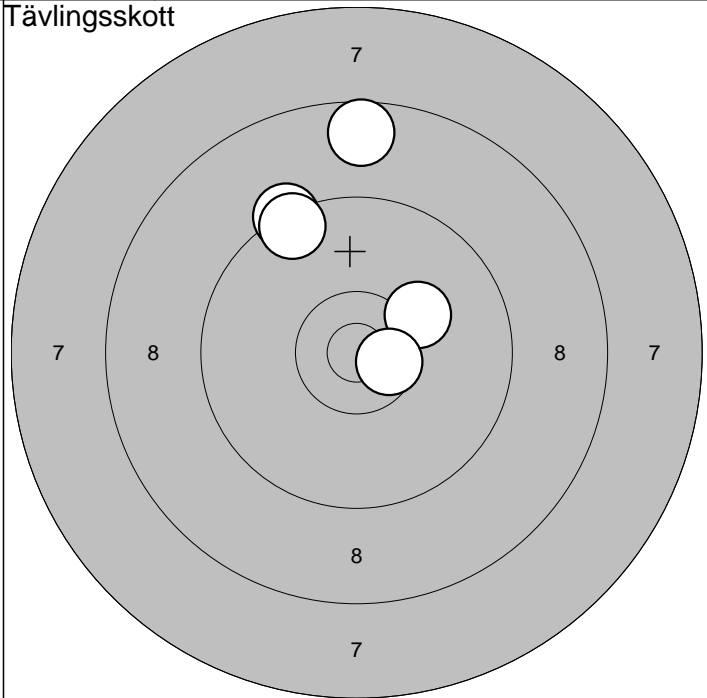

6: 8,6 ↑
7: 9,3 ↗
8:10,2 ↗
9:10,6* →
10: 9,5 ↗

Serie: 46,0
Summa: 93,0

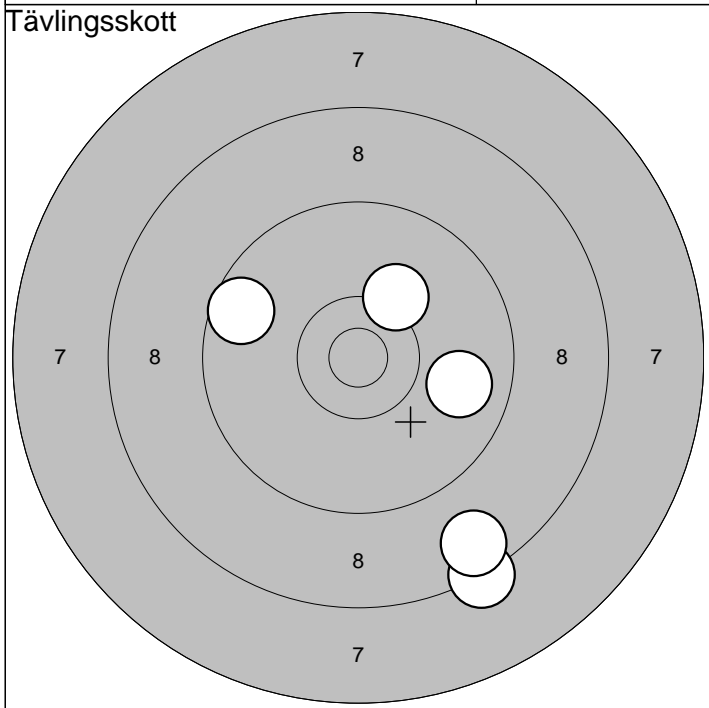

11: 8,3 ↘
12: 9,8 →
13:10,2 ↗
14: 9,6 ↗
15: 8,6 ↘

Serie: 44,0
Summa: 137,0

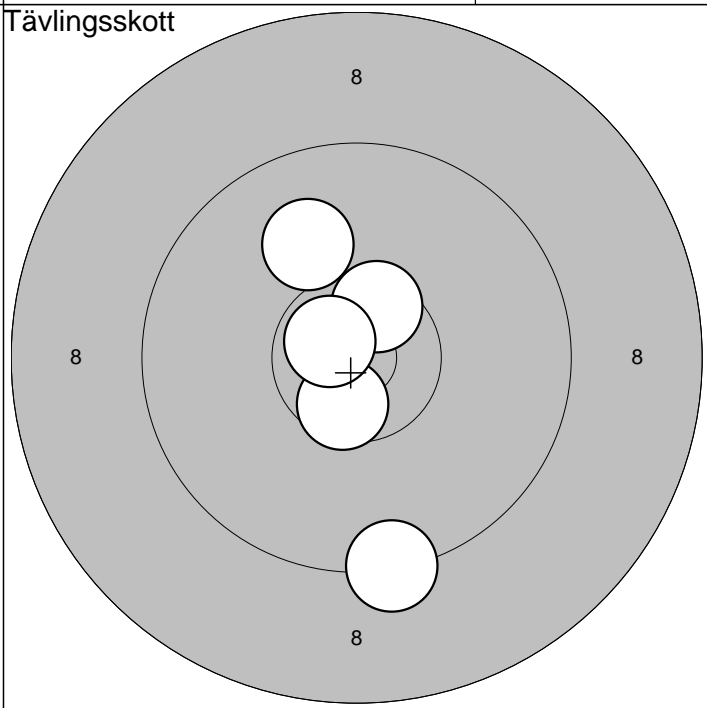

16:10,0 ↗
17:10,6* ↘
18: 9,3 ↘
19:10,5* ↗
20:10,7* ↗

Serie: 49,0
Summa: 186,0

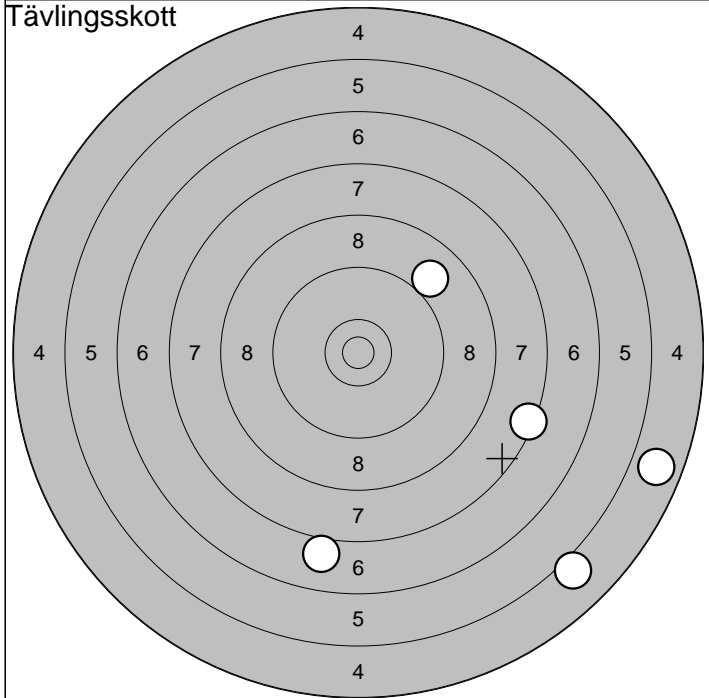

1: 7,4 →
2: 7,0 ↓
3: 4,8 →
4: 5,1 ↓
5: 9,0 ↗

Serie:	32,0
Summa:	32,0

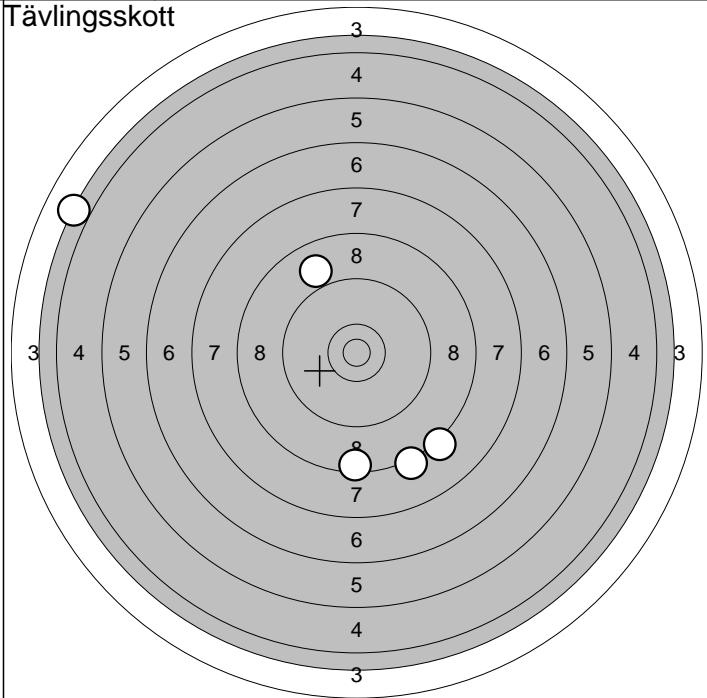

6: 8,5 ↓
7: 8,2 ↓
8: 8,2 ↓
9: 8,9 ↗
10: 4,0 ↖

Serie:	36,0
Summa:	68,0

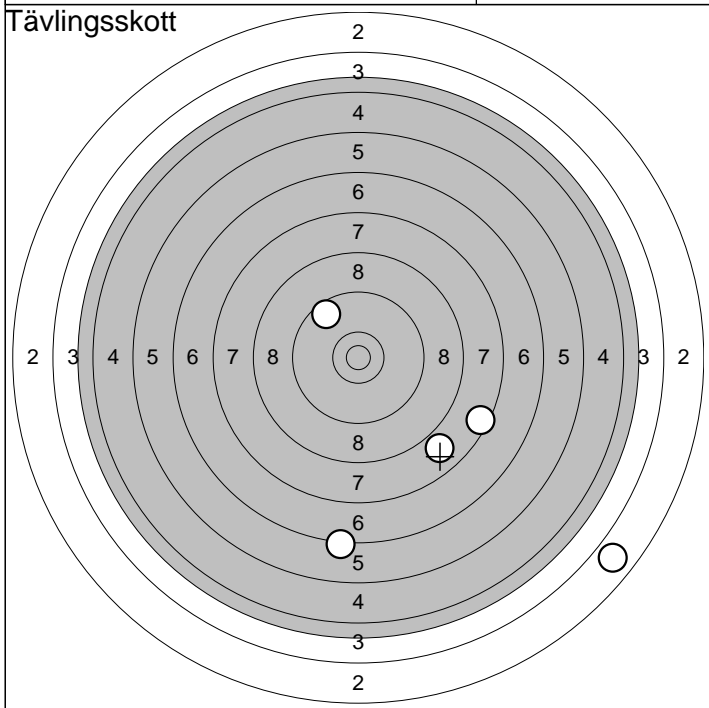

11: 7,9 ↓
12: 7,5 ↓
13: 9,6 ↗
14: 6,3 ↓
15: 2,8 ↓

Serie:	31,0
Summa:	99,0

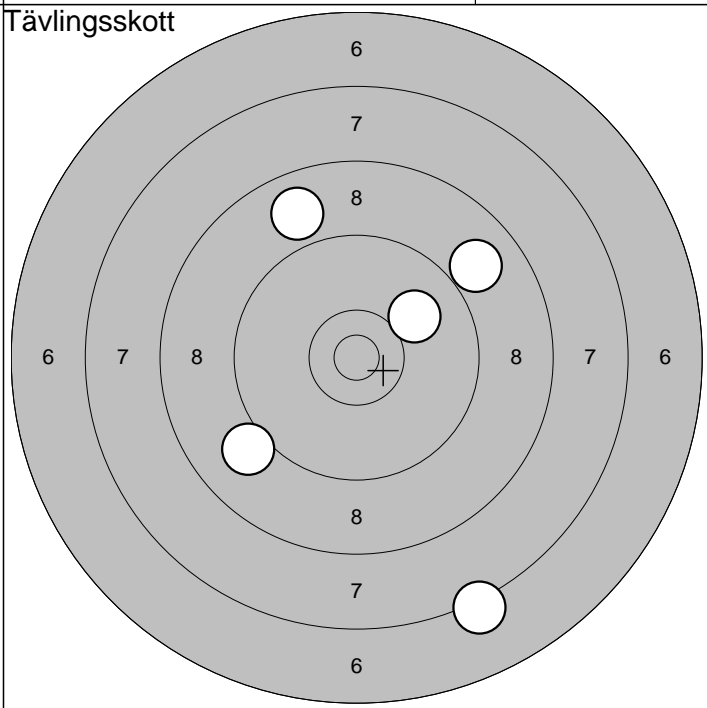

16: 8,9 ↗
17: 8,9 ↗
18: 10,0 ↗
19: 9,0 ↖
20: 7,2 ↓

Serie:	42,0
Summa:	141,0

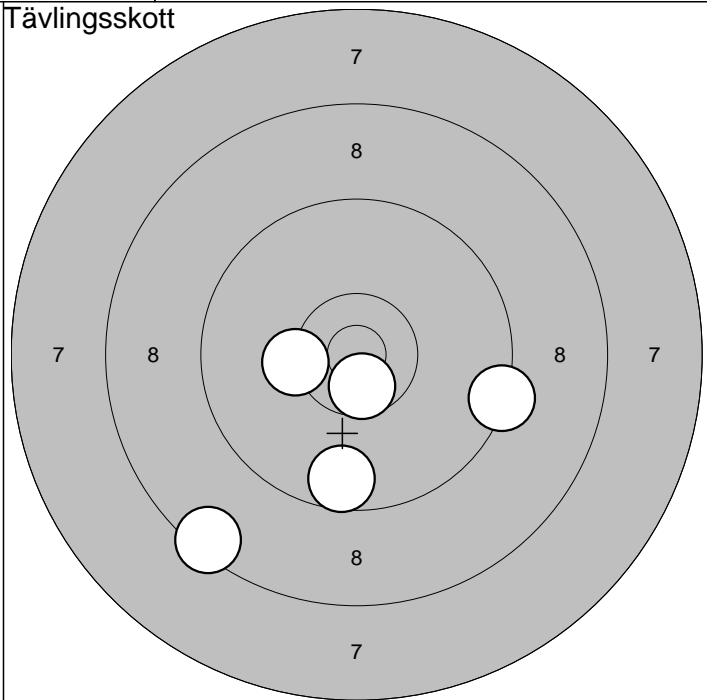
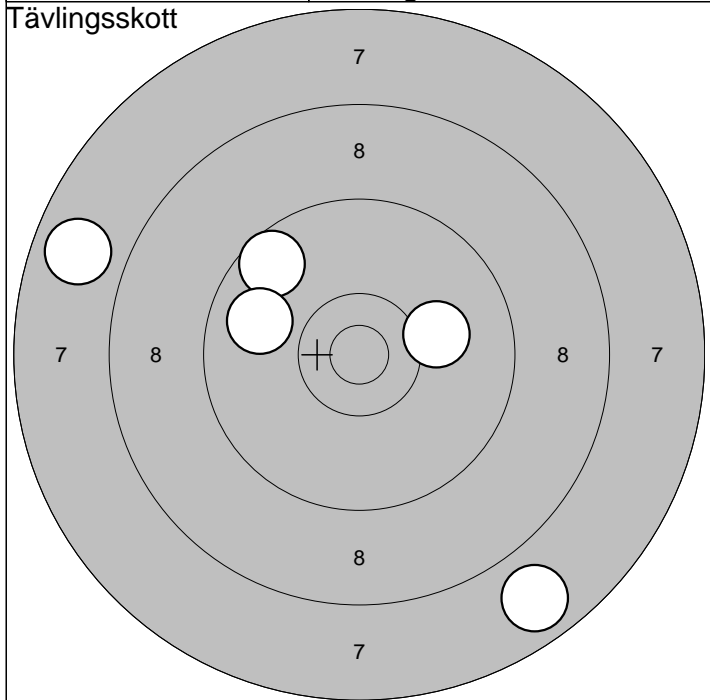

1: 10,1 →	Serie: 42,0
2: 9,6 ↗	
3: 7,8 ↖	Summa: 42,0
4: 9,8 ↖	
5: 7,8 ↘	

6: 9,3 →	Serie: 46,0
7: 10,3* ←	
8: 10,6* ↓	Summa: 88,0
9: 8,4 ↙	
10: 9,6 ↓	

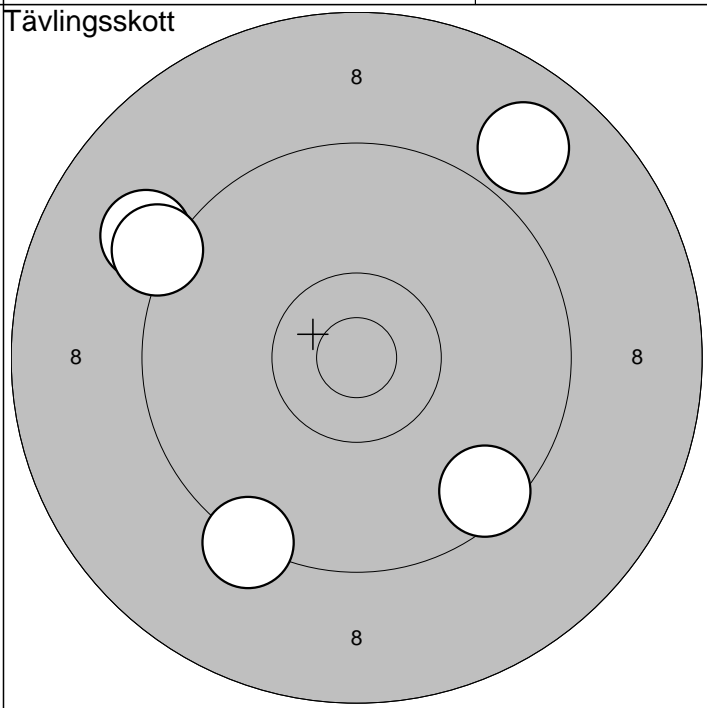
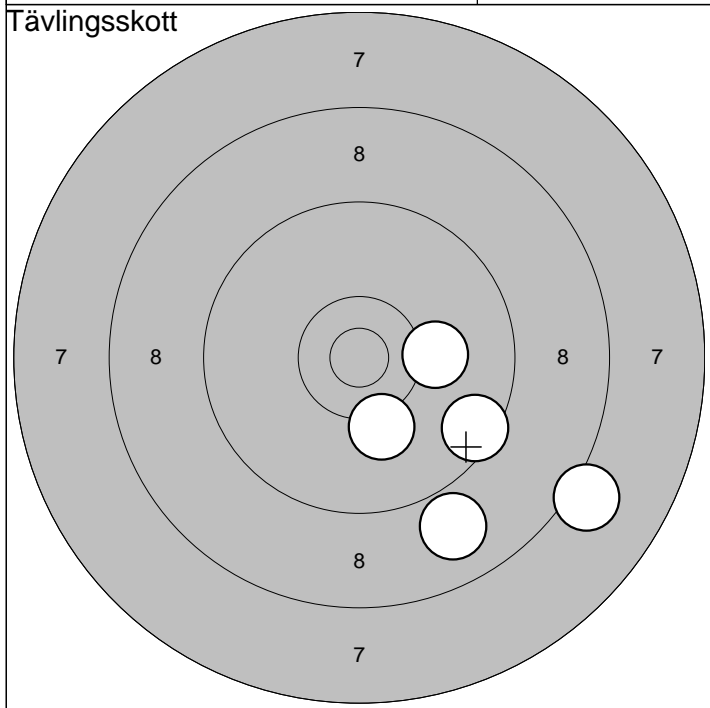

11: 8,9 ↘	Serie: 45,0
12: 9,5 ↘	
13: 10,1 →	Summa: 133,0
14: 8,1 ↘	
15: 10,2 ↘	

16: 9,1 ↖	Serie: 44,0
17: 9,3 ↘	
18: 9,2 ↖	Summa: 177,0
19: 8,9 ↗	
20: 9,5 ↘	

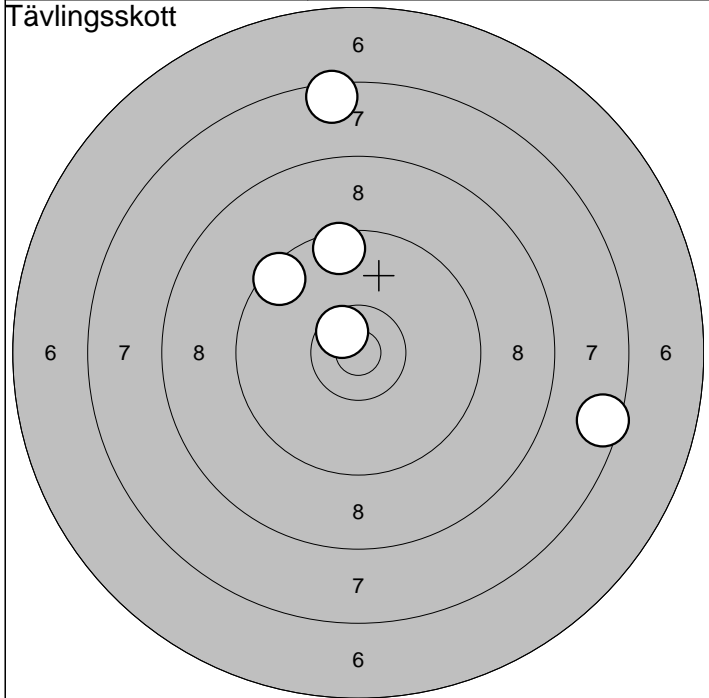

1: 9,5 ↖	Serie:	42,0
2: 7,5 ↑		
3:10,6* ↖	Summa:	42,0
4: 7,5 →		
5: 9,5 ↑		

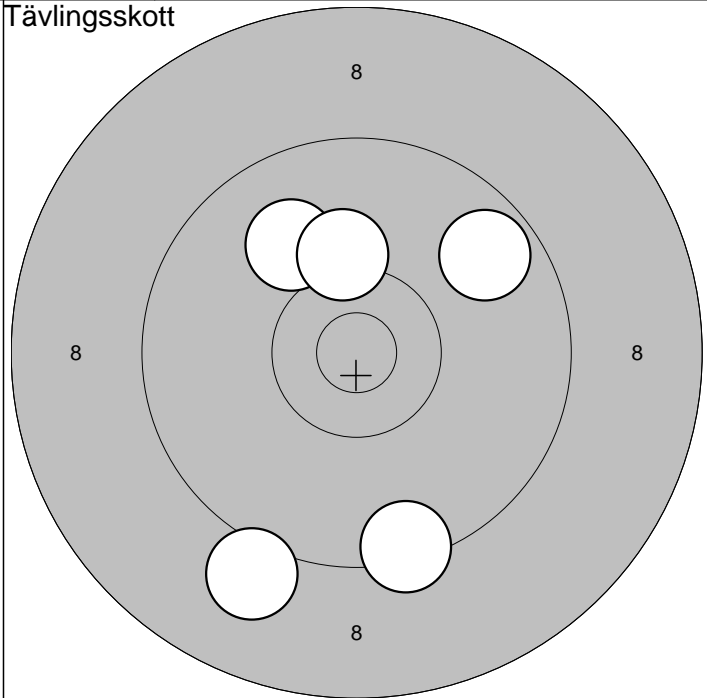

6:10,0 ↖	Serie:	47,0
7:10,2 ↑		
8: 9,7 ↗	Summa:	89,0
9: 9,1 ↘		
10: 9,4 ↘		

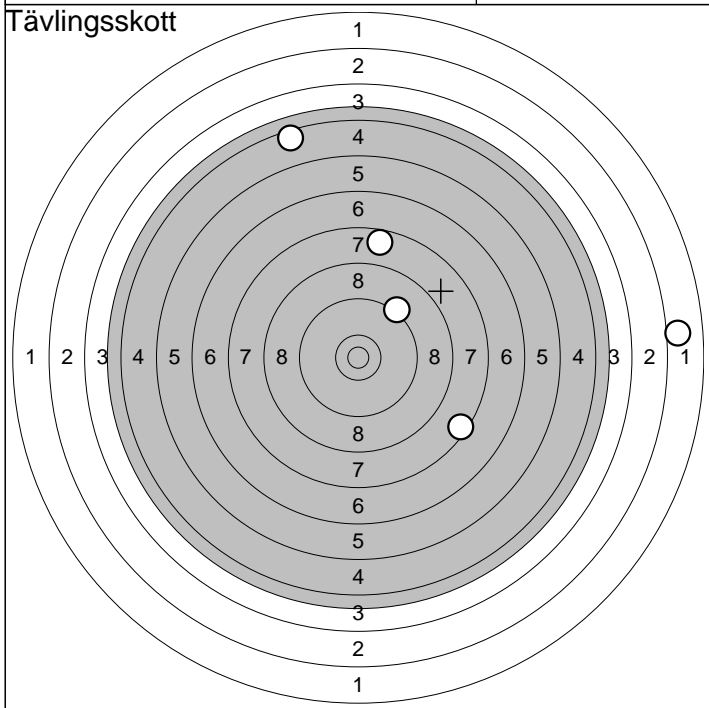

11: 2,0 →	Serie:	29,0
12: 7,7 ↑		
13: 7,5 ↘	Summa:	118,0
14: 4,5 ↑		
15: 9,2 ↗		

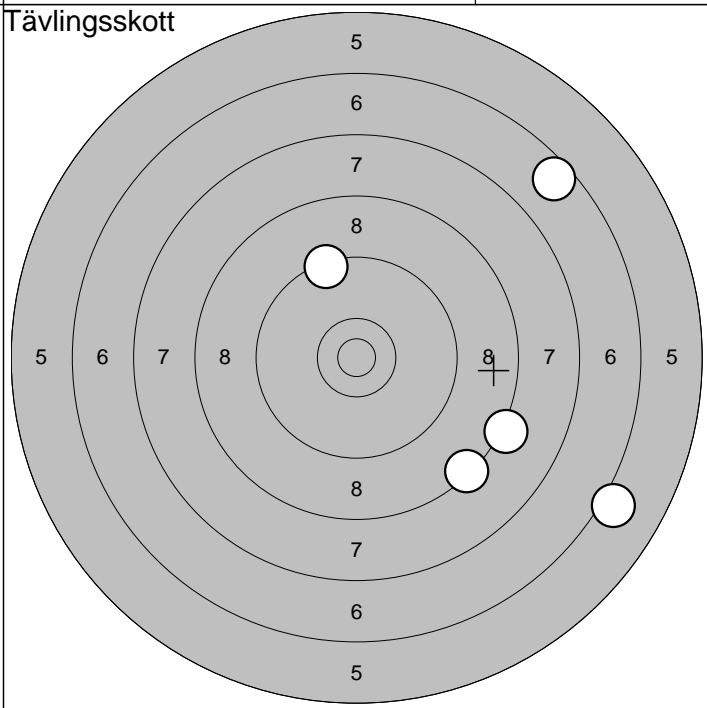

16: 6,6 ↗	Serie:	37,0
17: 8,2 →		
18: 6,1 ↘	Summa:	155,0
19: 9,4 ↑		
20: 8,4 ↘		

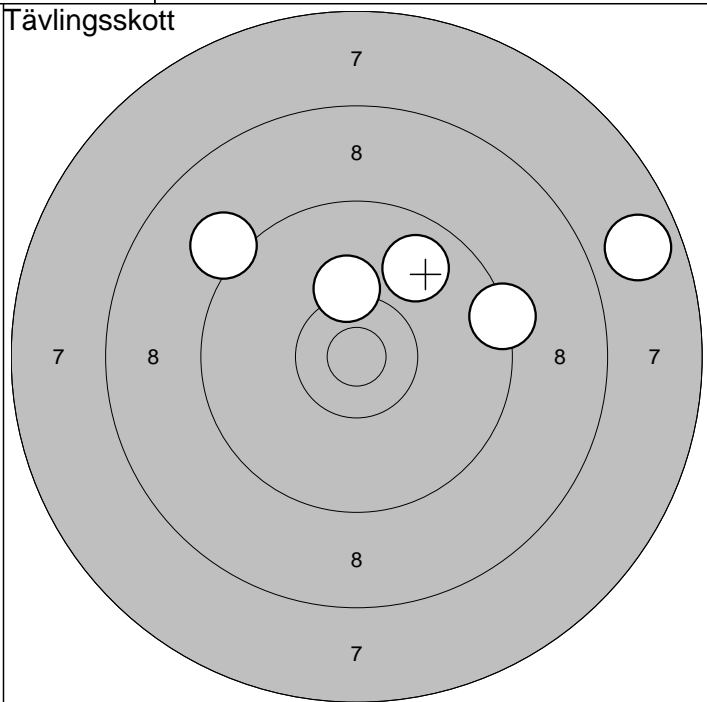
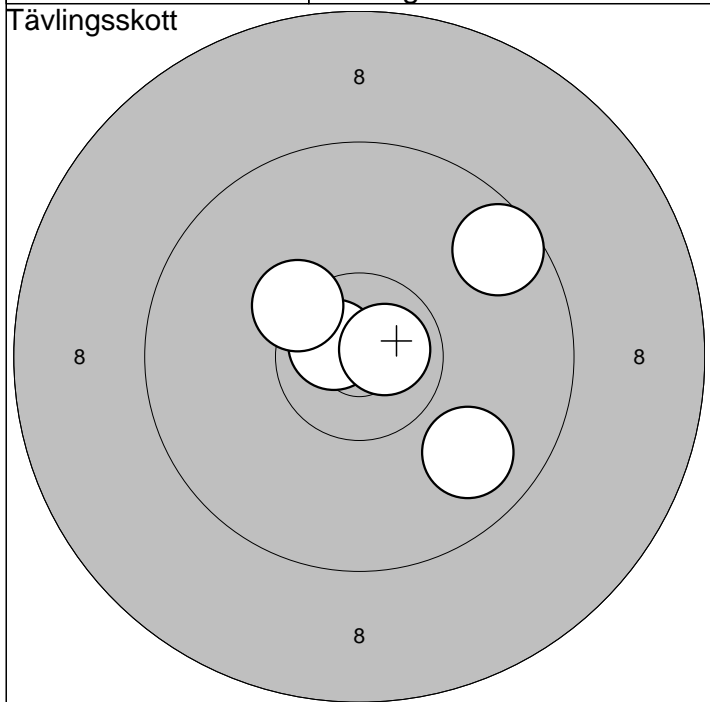

1: 9,8 ↘	Serie: 48,0
2: 9,6 ↗	
3: 10,7* ↖	Summa: 48,0
4: 10,7* →	
5: 10,3* ↖	

6: 7,8 →	Serie: 44,0
7: 10,2 ↑	
8: 9,1 ↖	Summa: 92,0
9: 9,8 ↗	
10: 9,4 →	

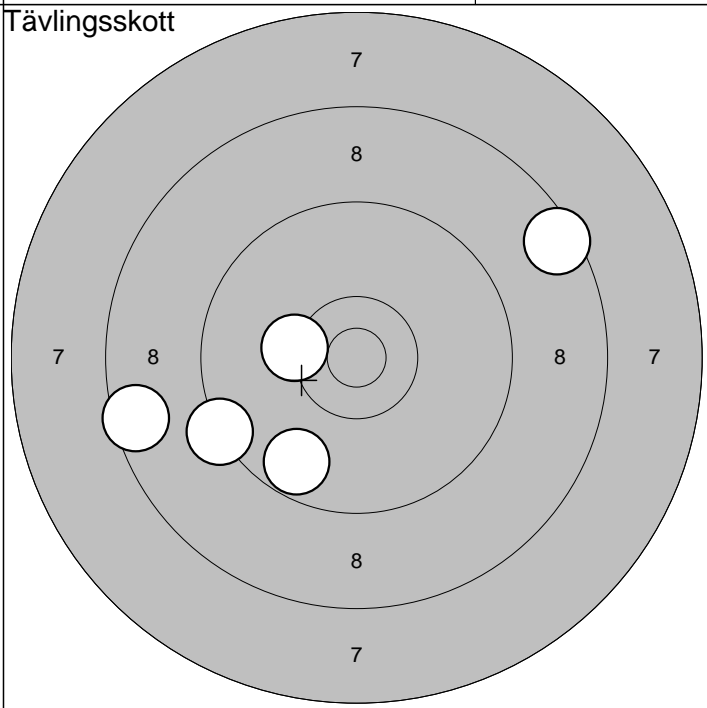
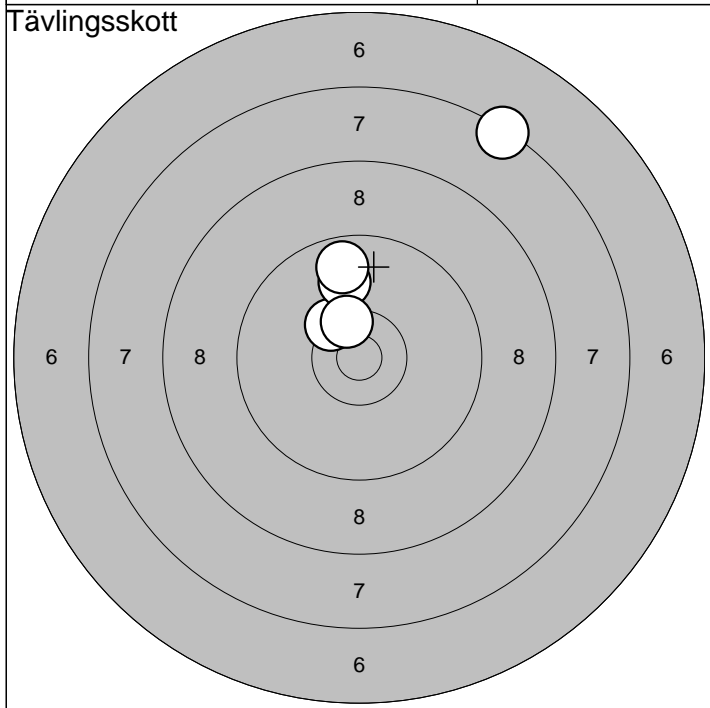

11: 10,4* ↖	Serie: 45,0
12: 9,9 ↑	
13: 7,4 ↗	Summa: 137,0
14: 10,4* ↑	
15: 9,7 ↑	

16: 8,5 →	Serie: 44,0
17: 8,5 ←	
18: 9,7 ↘	Summa: 181,0
19: 10,3* ←	
20: 9,3 ↖	

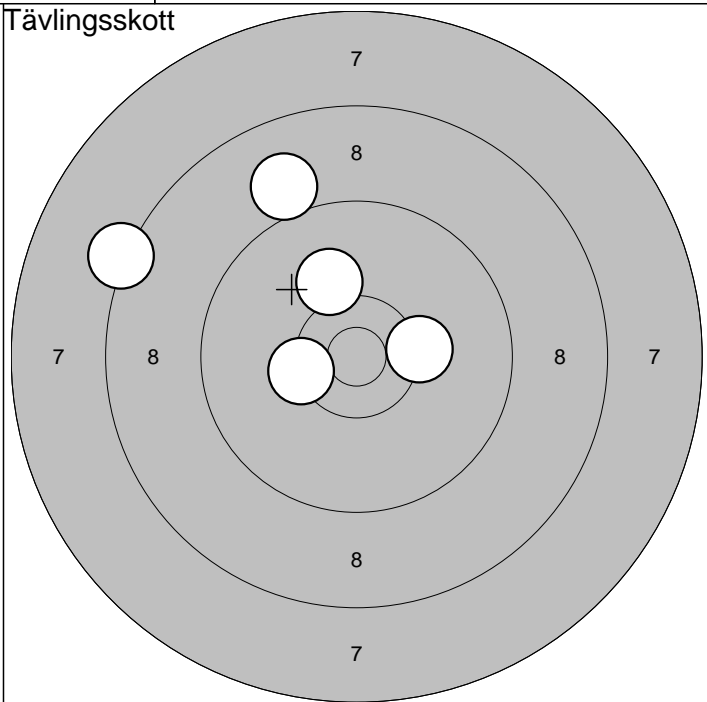
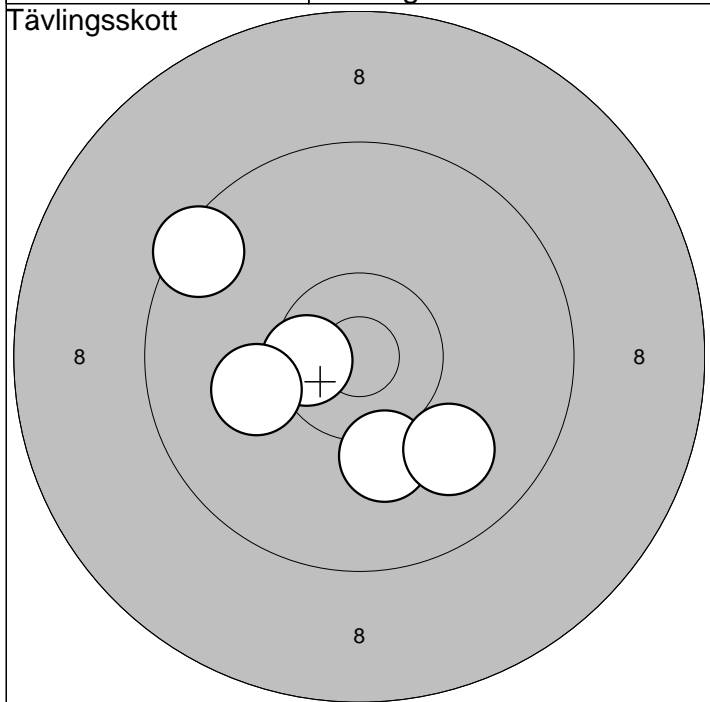

1:10,2 ↓	Serie: 49,0
2: 9,5 ↗	
3:10,5* ←	Summa: 49,0
4:10,1 ←	
5:10,0 ↓	

6:10,3 →	Serie: 47,0
7:10,1 ↗	
8:10,3* ←	Summa: 96,0
9: 8,3 ↖	
10: 9,0 ↗	

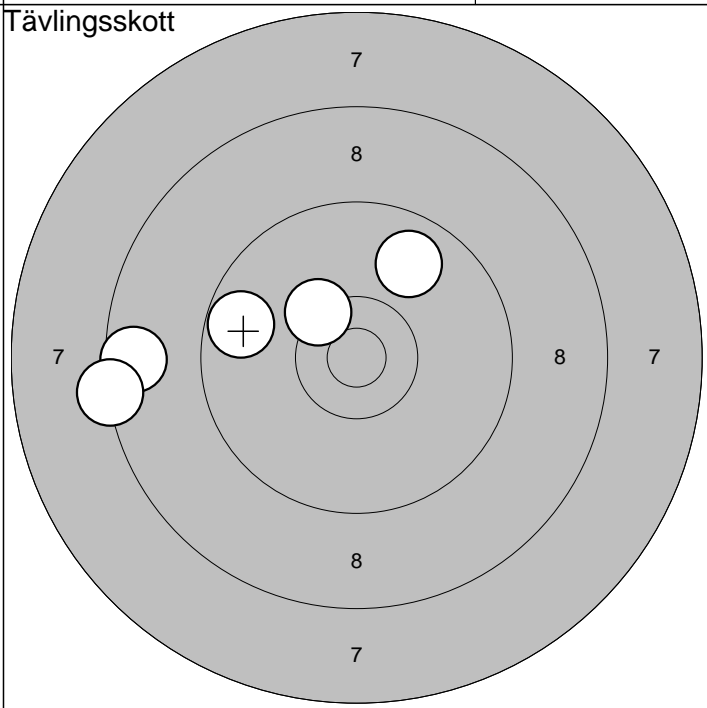
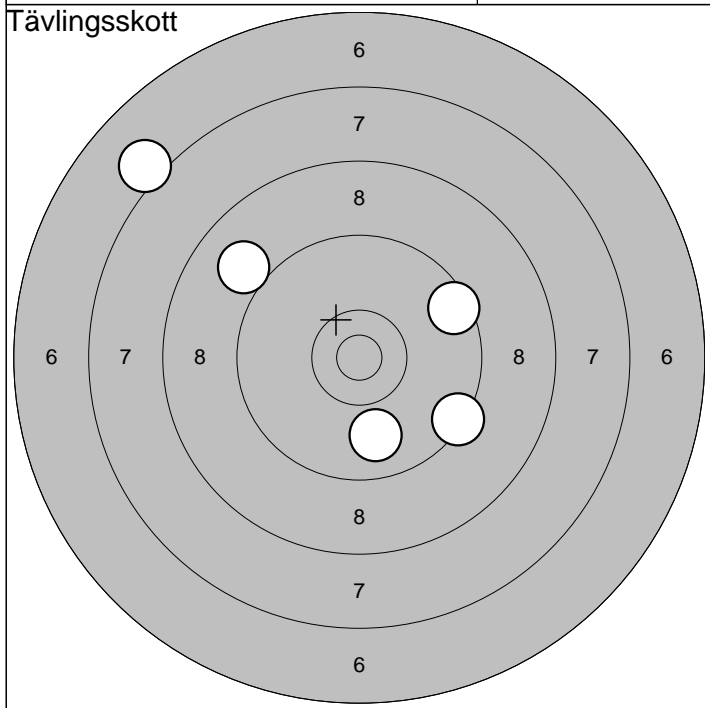

11: 9,4 ↘	Serie: 43,0
12: 7,1 ↗	
13: 9,0 ↗	Summa: 139,0
14: 9,5 ↗	
15: 9,9 ↓	

16: 8,6 ←	Serie: 44,0
17:10,3* ↗	
18: 9,8 ↗	Summa: 183,0
19: 8,3 ←	
20: 9,7 ←	

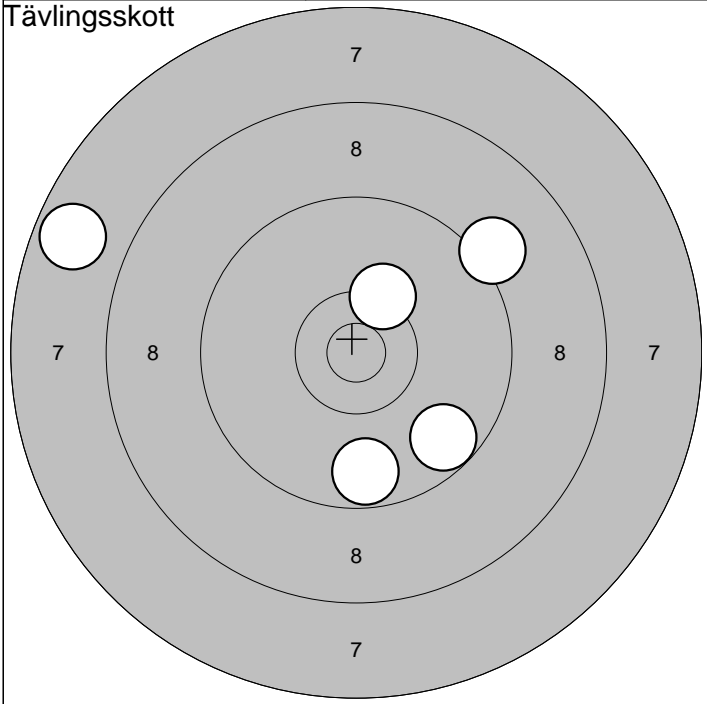

1: 7,7 ↙	Serie: 44,0
2: 9,7 ↘	
3: 10,3* ↗	
4: 9,7 ↓	
5: 9,2 ↗	
Summa: 44,0	

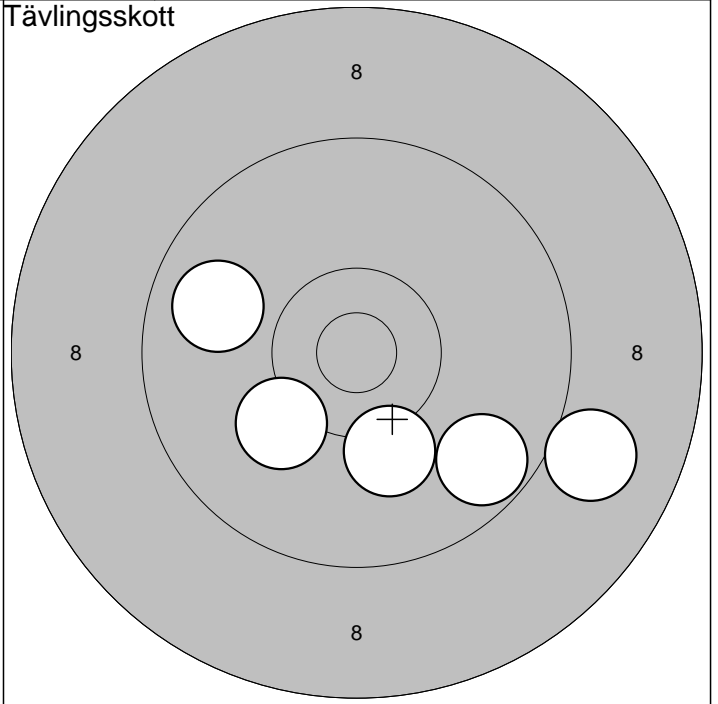

6: 9,7 ↘	Serie: 47,0
7: 10,2 ↓	
8: 9,8 ↙	
9: 9,0 ↘	
10: 10,2 ↙	
Summa: 91,0	

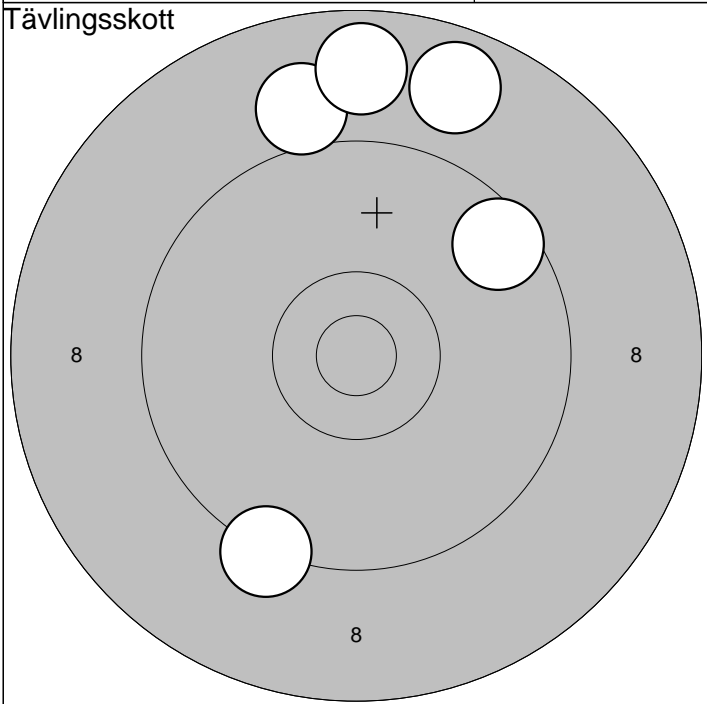

11: 9,6 ↗	Serie: 43,0
12: 9,3 ↓	
13: 9,0 ↗	
14: 8,8 ↗	
15: 8,8 ↗	
Summa: 134,0	

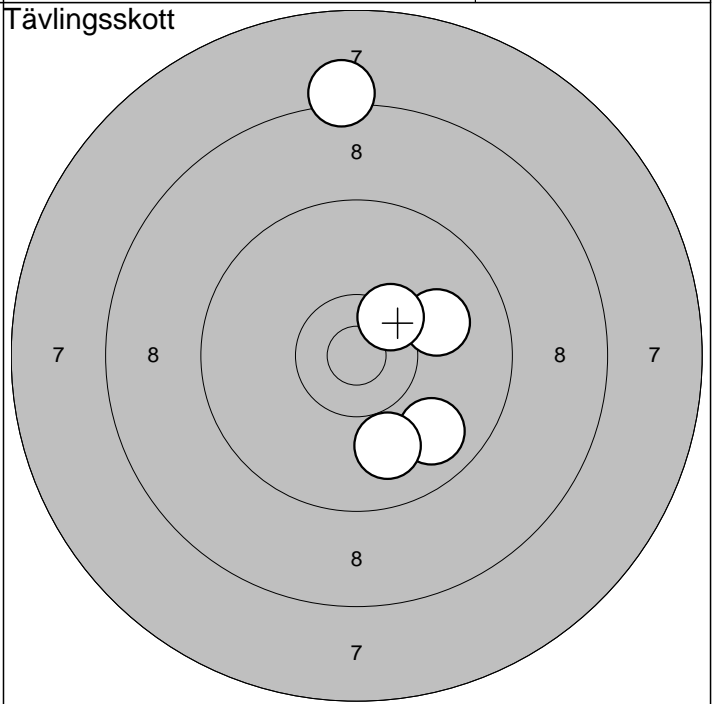

16: 10,0 ↗	Serie: 46,0
17: 9,8 ↘	
18: 10,4* ↗	
19: 8,2 ↗	
20: 9,9 ↓	
Summa: 180,0	

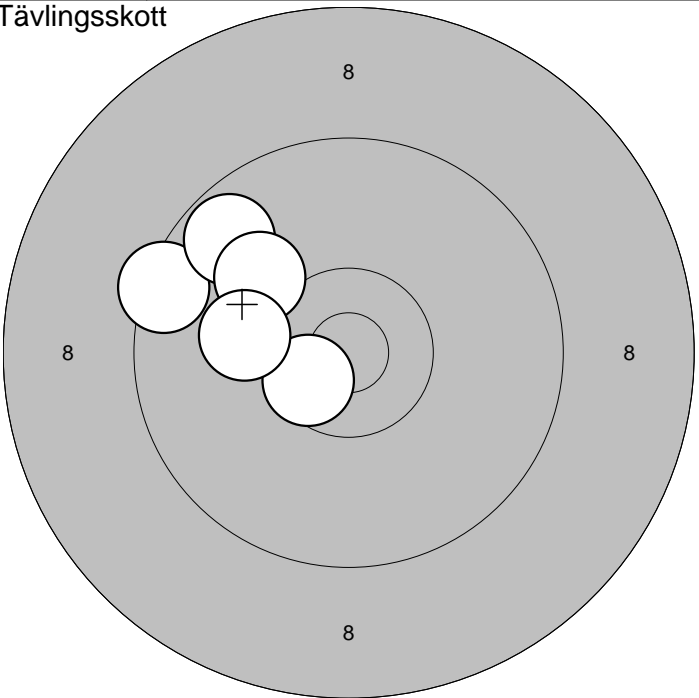
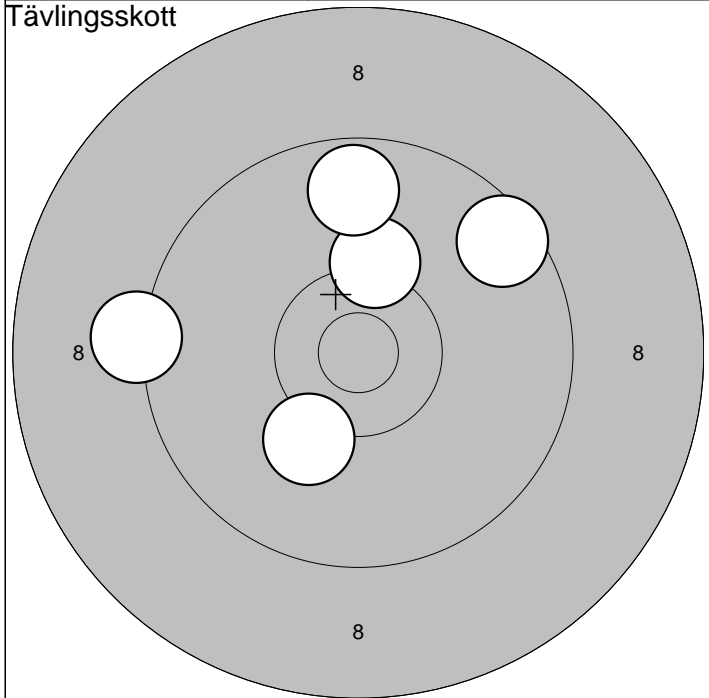

1: 9,2 ←	Serie: 47,0
2: 10,2 ↑	
3: 9,6 ↗	Summa: 47,0
4: 9,7 ↑	
5: 10,2 ↘	

6: 9,5 ←	Serie: 48,0
7: 9,7 ↗	
8: 10,6* ↘	Summa: 95,0
9: 10,1 ↗	
10: 10,1 ←	

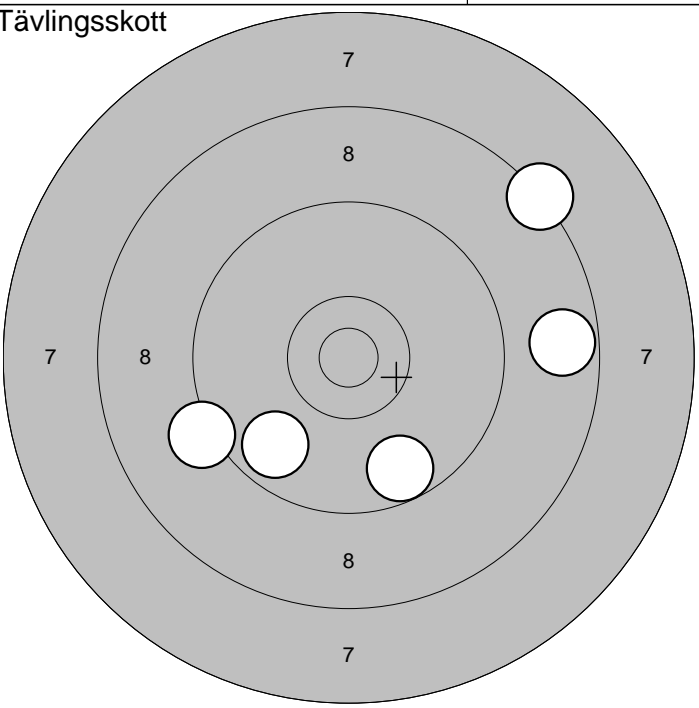
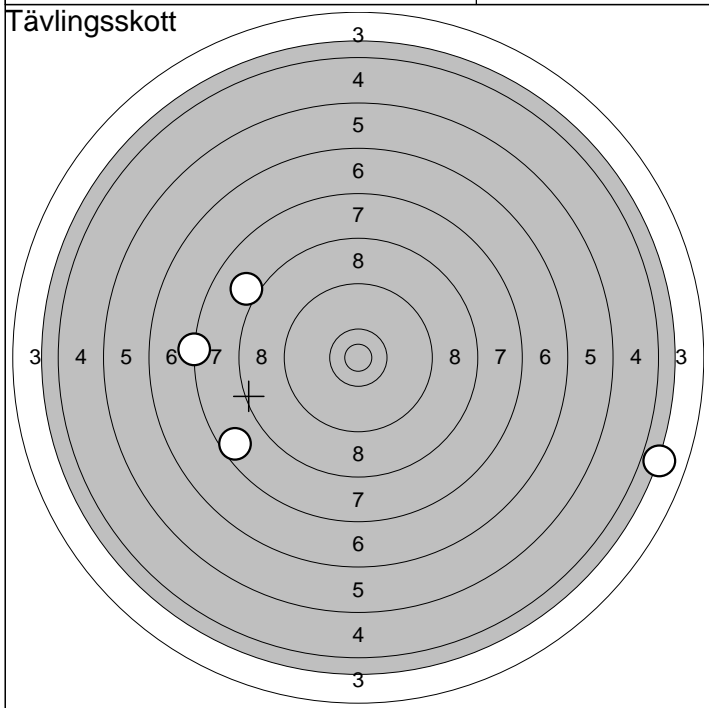

11: 8,1 ↗	Serie: 25,0
12: 3,9 →	
13: 7,3 ←	Summa: 120,0
14: 0,0 ←	
15: 7,6 ↘	

16: 9,7 ↘	Serie: 43,0
17: 9,7 ↘	
18: 8,3 ↗	Summa: 163,0
19: 9,2 ←	
20: 8,7 →	

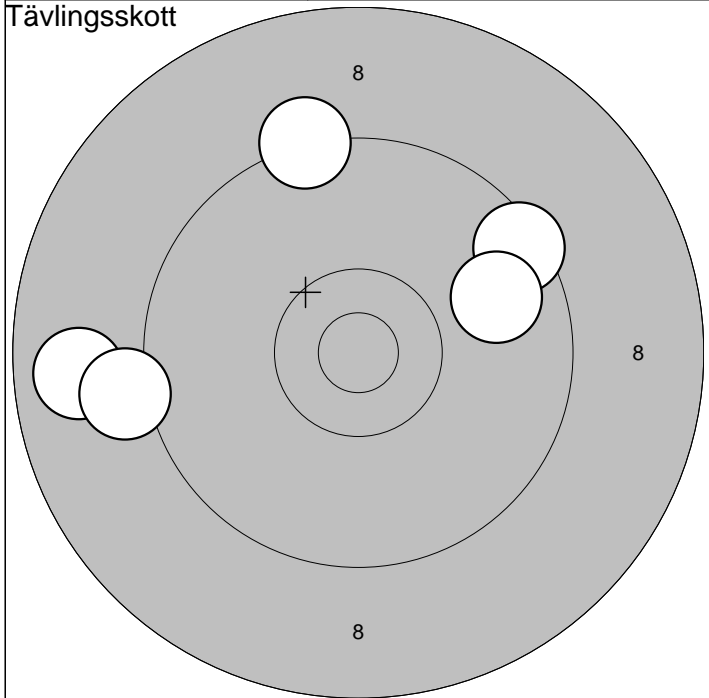

1: 8,8 ←
2: 9,5 ↗
3: 9,8 ↗
4: 9,3 ↑
5: 9,1 ←

Serie: 44,0
Summa: 44,0

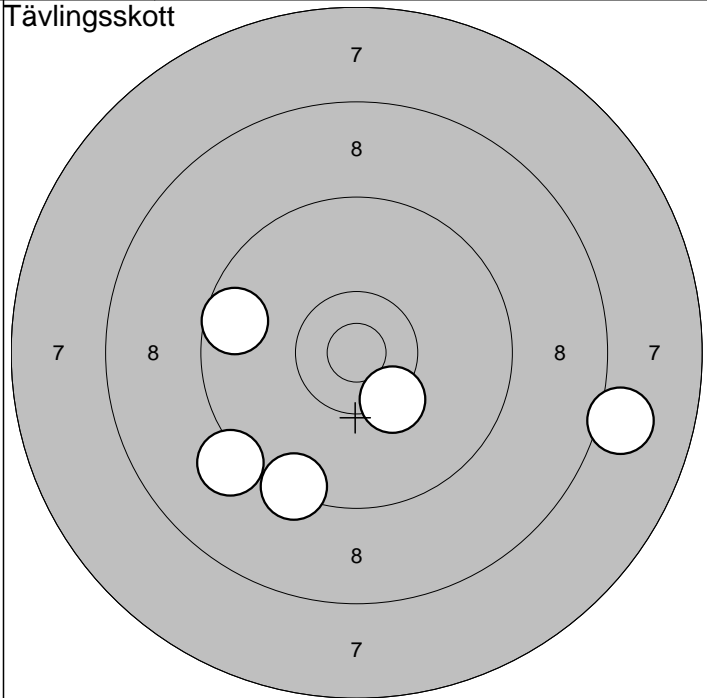

6: 9,6 ←
7:10,3* ↓
8: 8,1 →
9: 9,2 ↓
10: 9,4 ↓

Serie: 45,0
Summa: 89,0

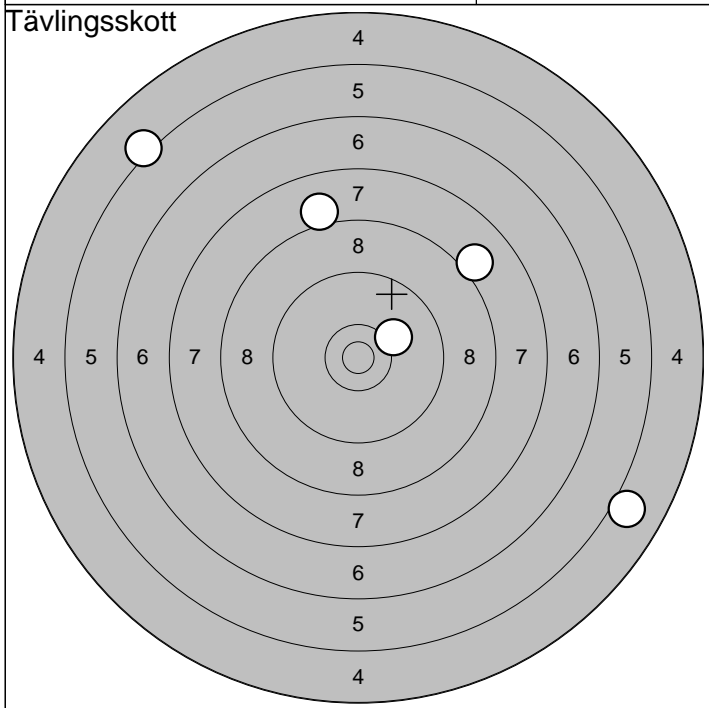

11: 8,1 ↑
12: 5,0 ↘
13: 5,2 ↖
14: 8,1 ↗
15:10,2 ↗

Serie: 36,0
Summa: 125,0

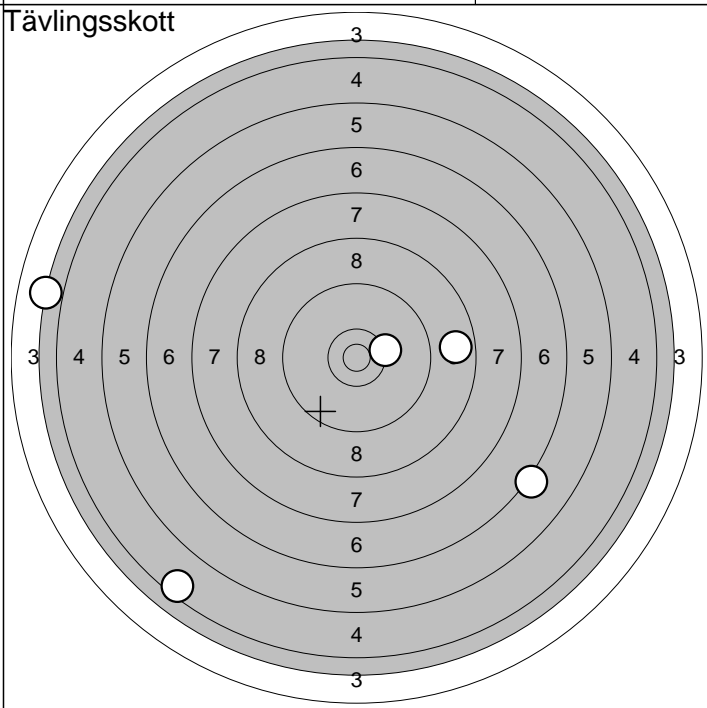

16: 4,5 ↓
17: 3,9 ←
18: 6,2 ↘
19:10,3 →
20: 8,7 →

Serie: 31,0
Summa: 156,0

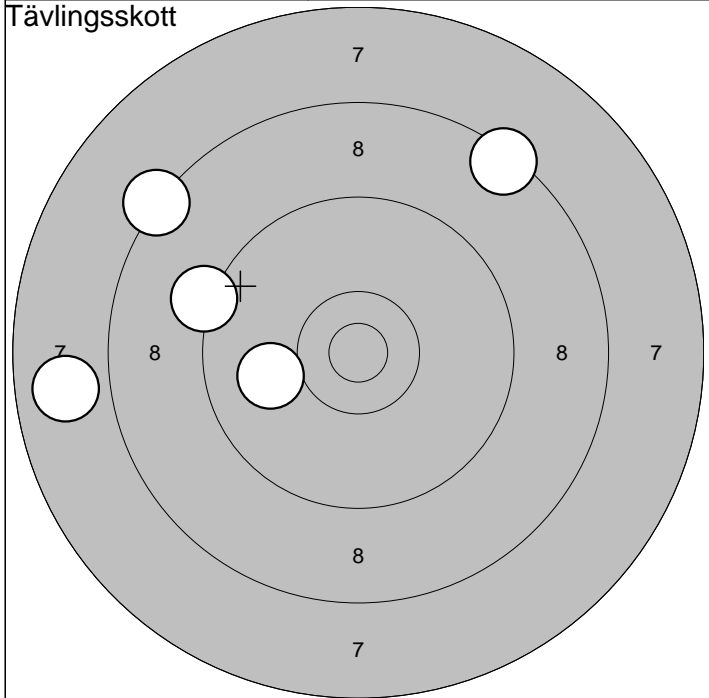

1: 7,8 ←
2: 9,2 ↙
3: 8,3 ↖
4: 8,4 ↗
5: 10,0 ←

Serie: 42,0	
Summa: 42,0	

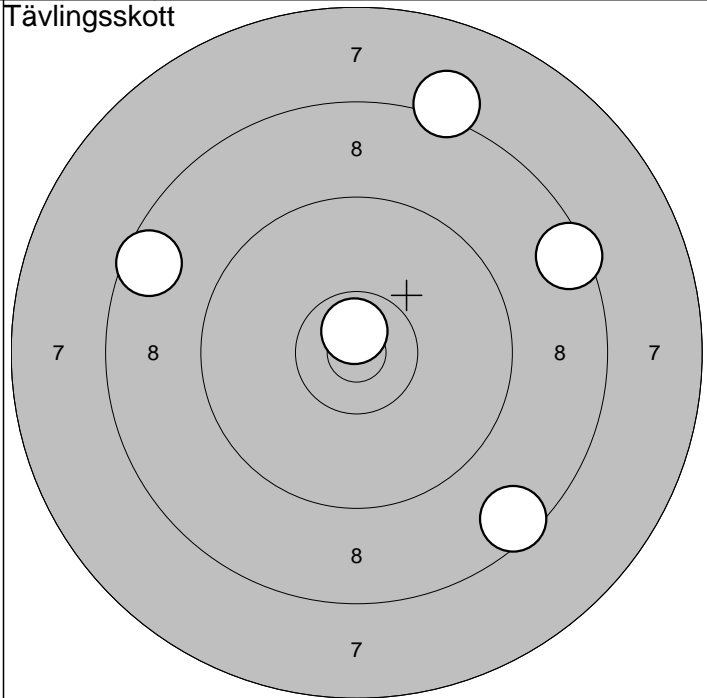

6: 10,7* ↑
7: 8,5 →
8: 8,6 ↖
9: 8,2 ↑
10: 8,5 ↘

Serie: 42,0	
Summa: 84,0	

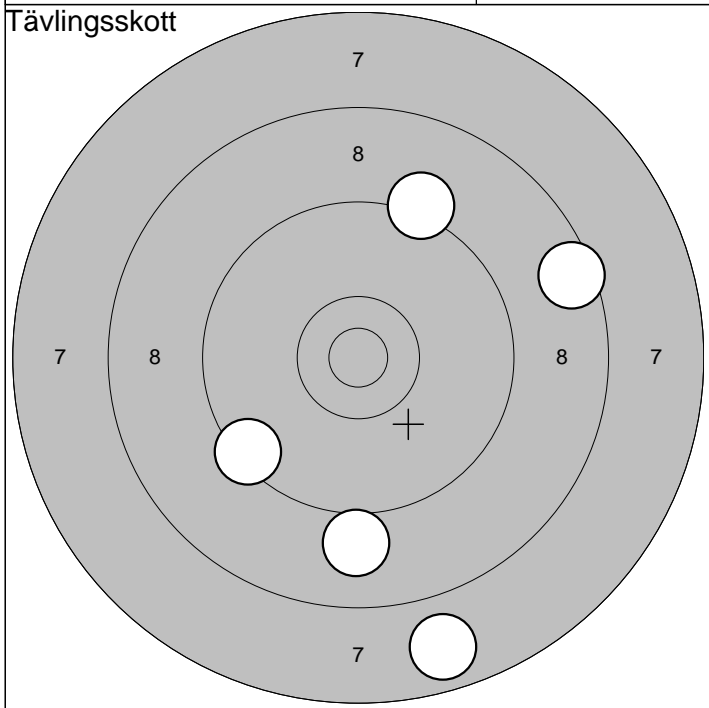

11: 7,8 ↓
12: 9,2 ↗
13: 9,0 ↓
14: 9,4 ↙
15: 8,5 →

Serie: 42,0	
Summa: 126,0	

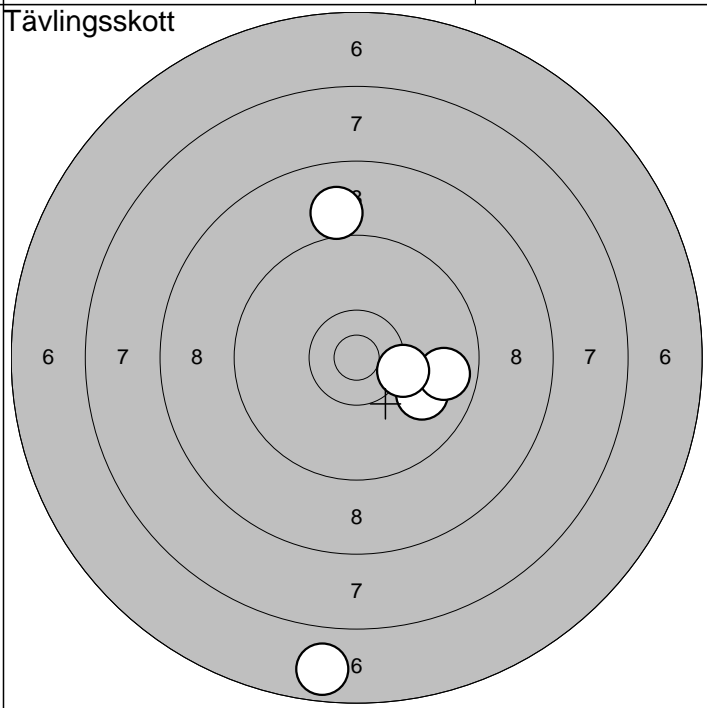

16: 9,9 ↘
17: 9,7 →
18: 10,3* →
19: 9,0 ↑
20: 6,7 ↓

Serie: 43,0	
Summa: 169,0	