

<p>20 Skott</p> 	<p>1: 9.3 ↗                  2: 1.0 ↗                  3: 4.9 ←                  4: 2.5 →                  5: 3.9 ↘</p>	<p>20 Skott</p> 	<p>6: 3.0 ←                  7: 1.4 ←                  8: 9.8 ←                  9: 3.0 ←                  10: 6.0</p>
Serie 19 (0x)		Serie 22 (0x)	
Total 19 (0x)		Total 41 (0x)	

<p>20 Skott</p> 	<p>12: 2.7 ↙                  13: 5.9 ↙                  14: 4.5 ↘                  15: 9.9 ↗</p>	<p>20 Skott</p> 	<p>16: 1.4 ←                  17: 0.0 ←                  18: 6.0 ↘                  19: 5.9 ↗                  20: 5.9 ↘</p>
Serie 20 (0x)		Serie 17 (0x)	
Total 61 (0x)		Total 78 (0x)	

<p>20 Skott</p> 	<p>21: 1.7 ↘</p>		
Serie 1 (0x)			
Total 79 (0x)			

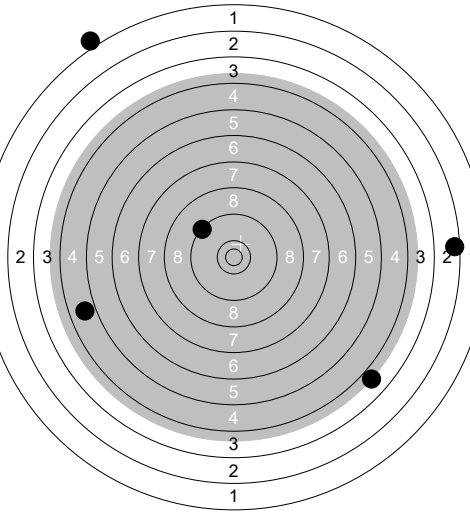
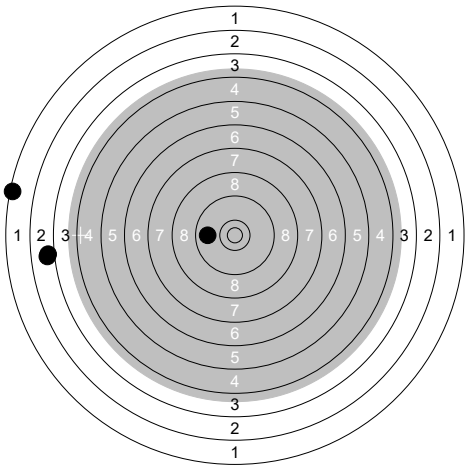
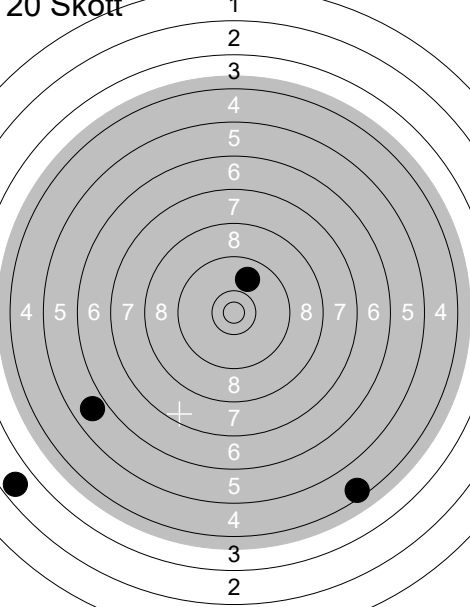
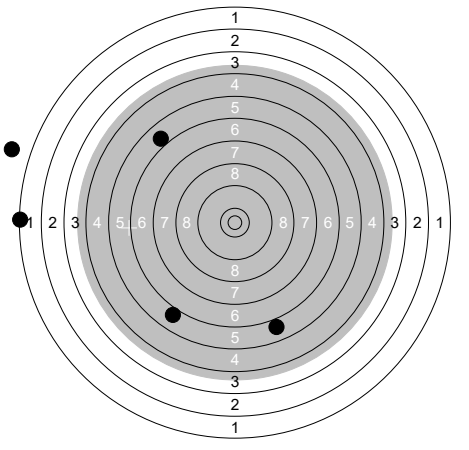
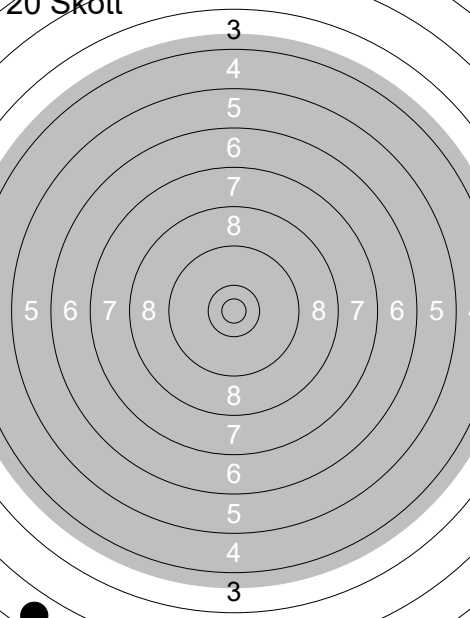
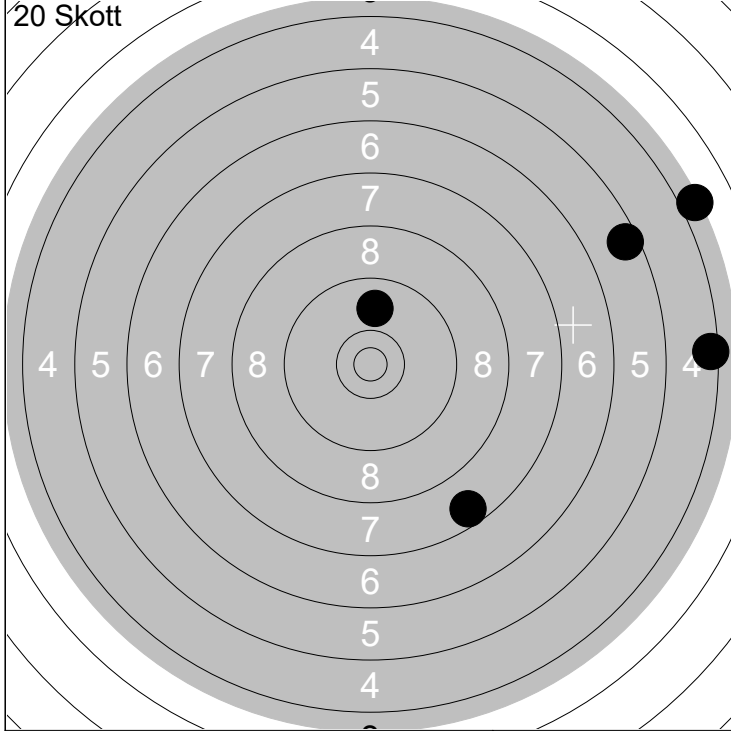

1:	4.0	↗
2:	4.4	→
3:	5.5	↗
4:	7.6	↘
5:	9.9	↑

Serie	29 (0x)
Total	29 (0x)

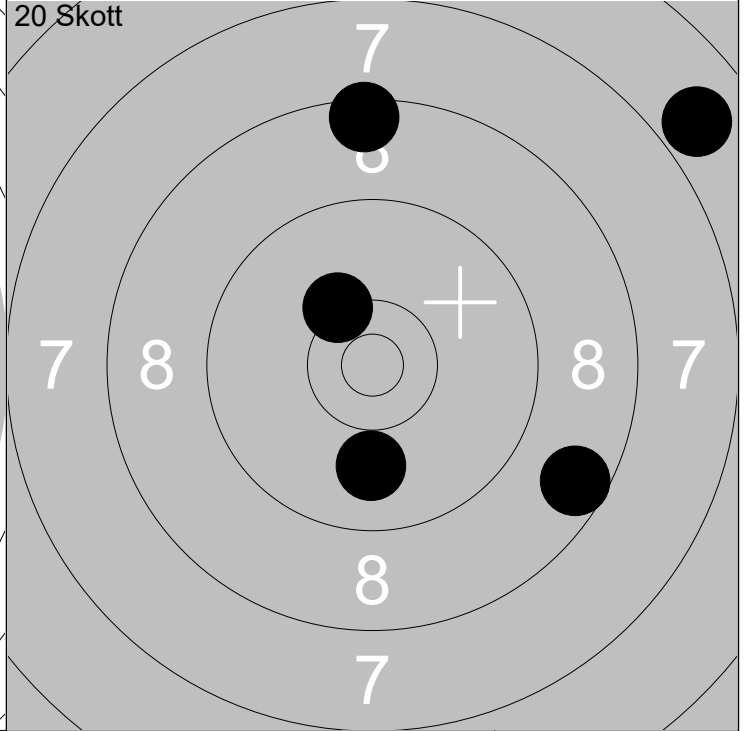

6:	8.5	↑
7:	9.9	↓
8:	8.6	↘
9:	6.9	↗
10:	10.3	↖

Serie	41 (0x)
Total	70 (0x)

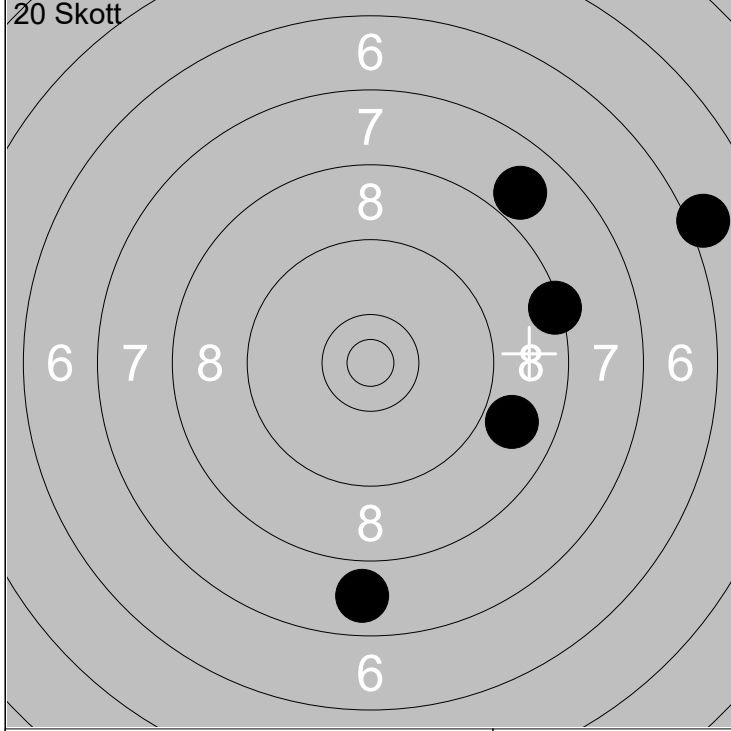

11:	6.1	↗
12:	7.8	↓
13:	8.9	↘
14:	8.4	↗
15:	7.9	↖

Serie	36 (0x)
Total	106 (0x)

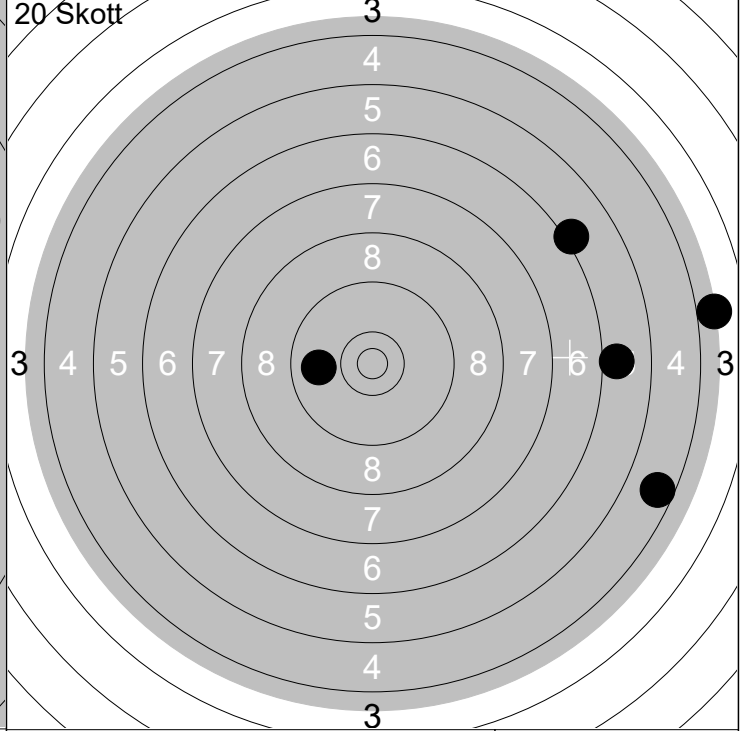

16:	9.9	←
17:	3.9	→
18:	6.0	→
19:	6.2	↗
20:	4.6	↘

Serie	28 (0x)
Total	134 (0x)

Skjutlag

1

Tavla

3

Simon Rataj

50m

KL11

16.05.2022

Månadstävling 1

Farhults uskf

20 Skott

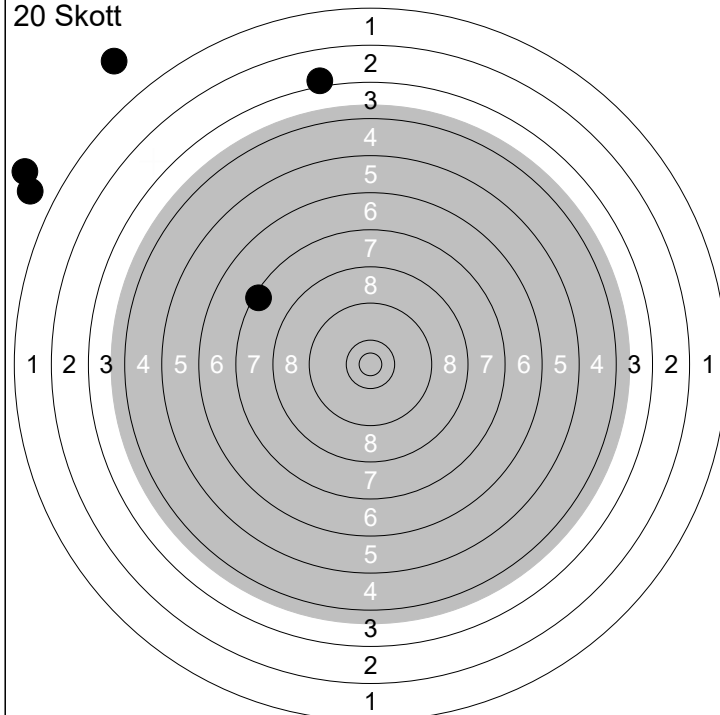

1: 0.0 ↖  
 2: 3.2 ↑  
 3: 7.4 ↗  
 4: 0.0 ↗  
 5: 0.0 ↗

Serie 10 (0x)

Total 10 (0x)

20 Skott

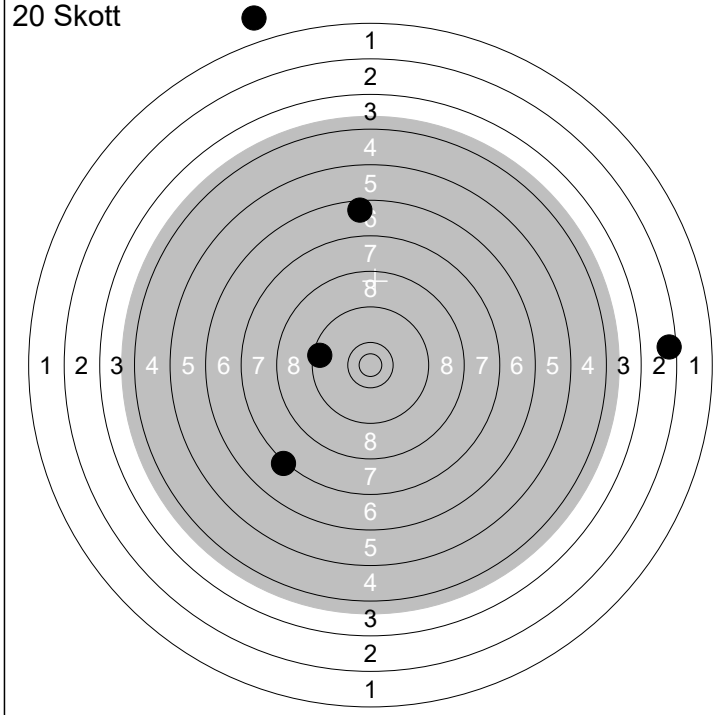

6: 2.5 →  
 7: 7.3 ↙  
 8: 0.0 ↑  
 9: 9.5 ←  
 10: 6.6 ↑

Serie 24 (0x)

Total 34 (0x)

20 Skott

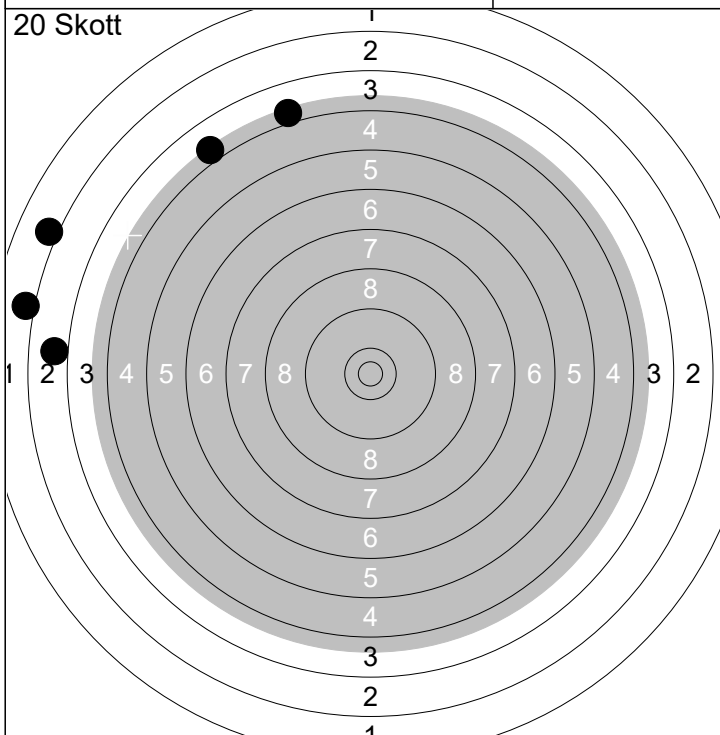

11: 4.0 ↑  
 12: 2.1 ←  
 13: 2.1 ↗  
 14: 4.0 ↗  
 15: 2.9 ←

Serie 14 (0x)

Total 48 (0x)

20 Skott

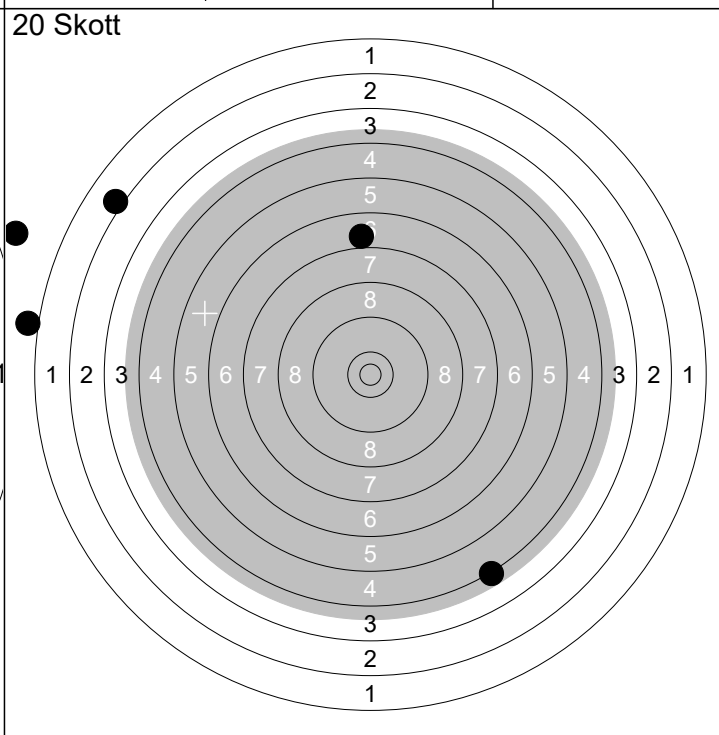

16: 0.0 ↖  
 17: 7.0 ↑  
 18: 1.0 ←  
 19: 4.3 ↙  
 20: 2.1 ↗

Serie 14 (0x)

Total 62 (0x)

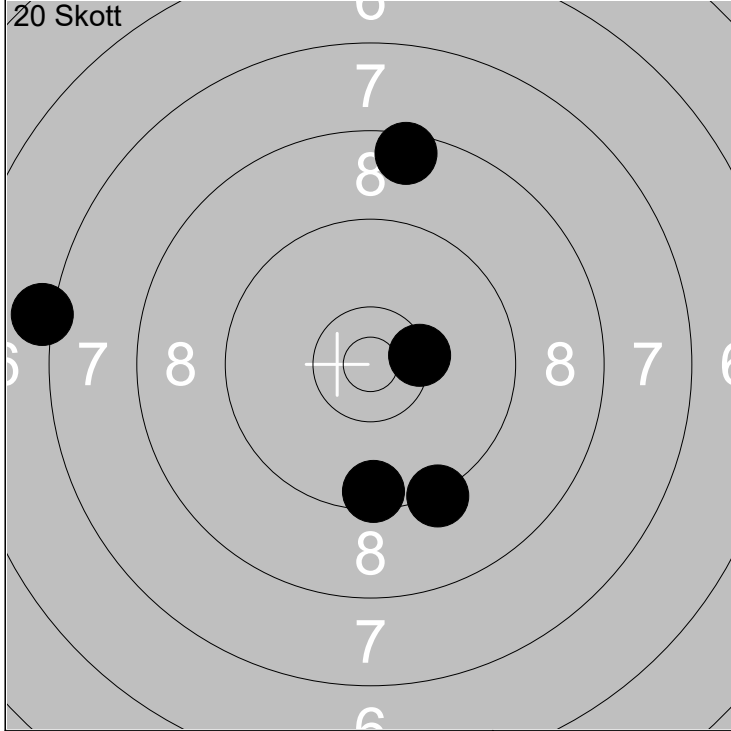

1:	8.5	↑
2:	7.2	←
3:	10.4x	→
4:	9.5	↓
5:	9.3	↘

Serie	43 ( 1x)
Total	43 ( 1x)

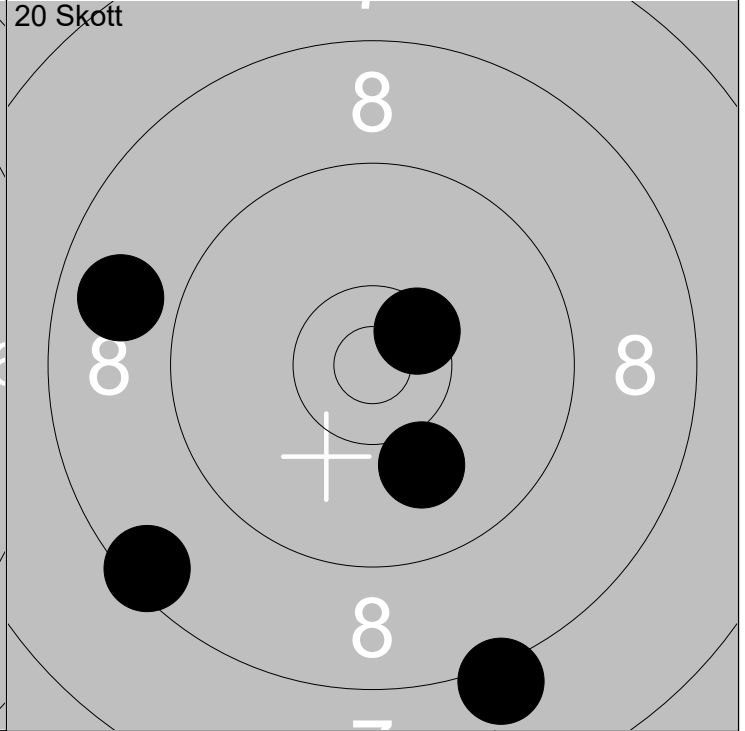

6:	10.5x	↗
7:	10.0	↓
8:	8.8	←
9:	8.5	↙
10:	8.2	↘

Serie	44 ( 1x)
Total	87 ( 2x)

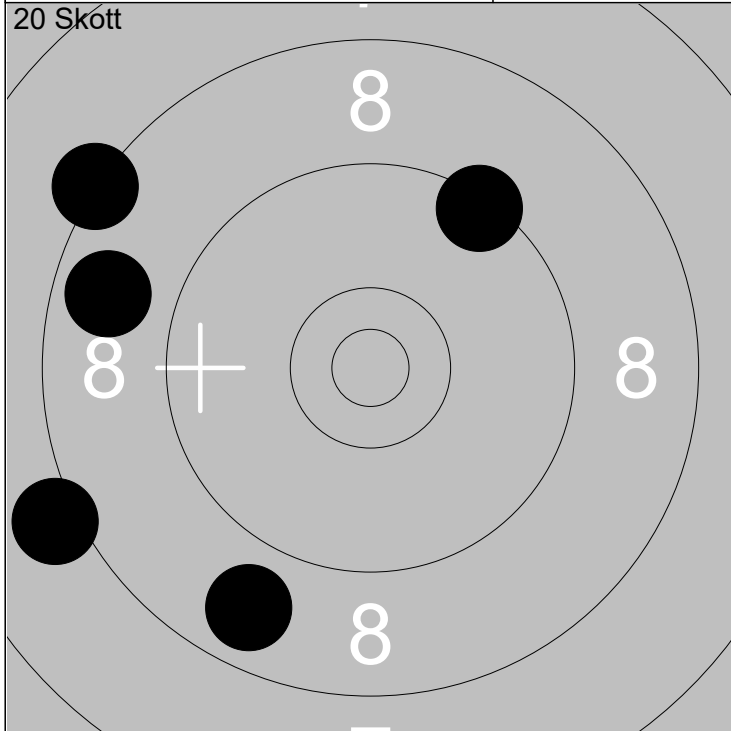

11:	8.1	←
12:	8.7	←
13:	8.8	↙
14:	9.4	↗
15:	8.3	↖

Serie	41 ( 0x)
Total	128 ( 2x)

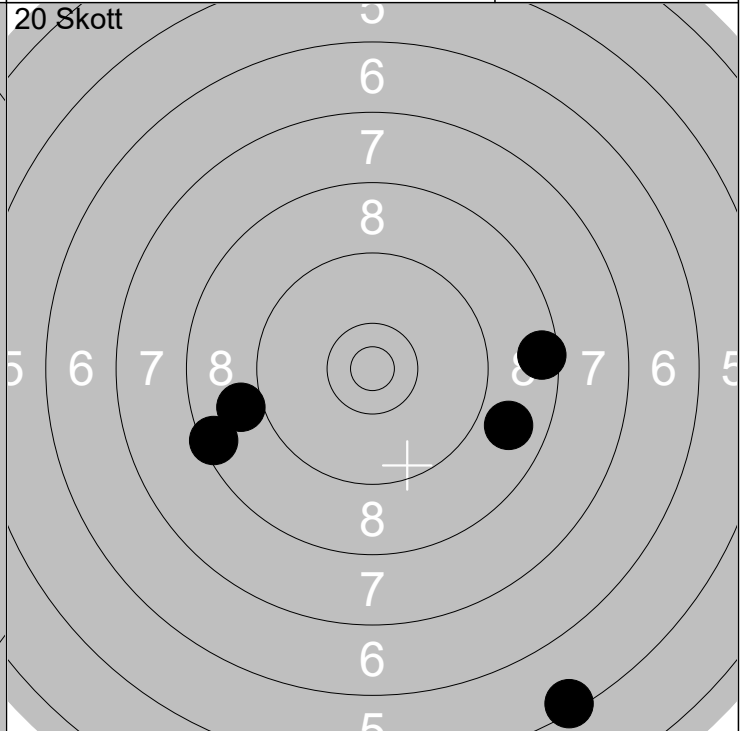

16:	8.5	→
17:	8.5	←
18:	9.0	←
19:	8.8	↗
20:	5.4	↘

Serie	38 ( 0x)
Total	166 ( 2x)

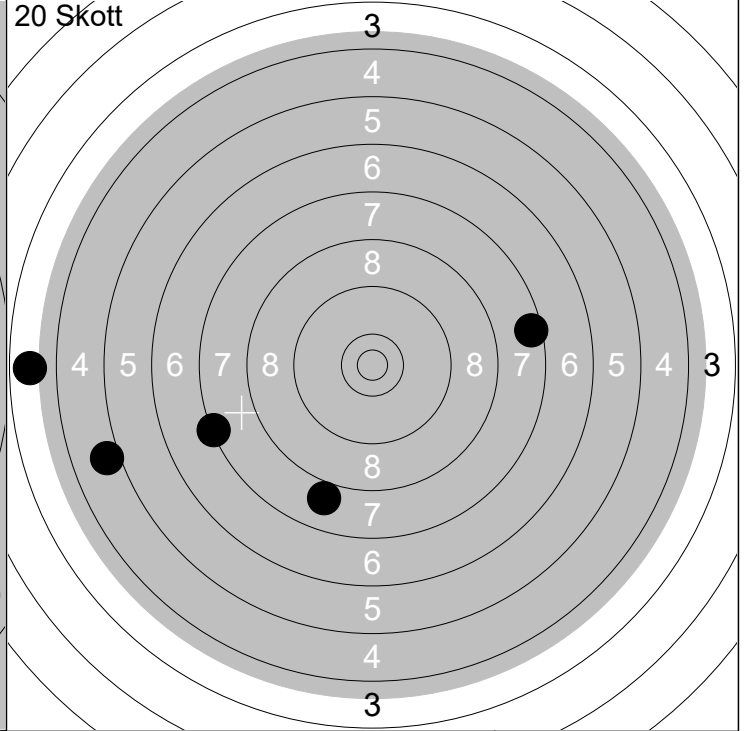
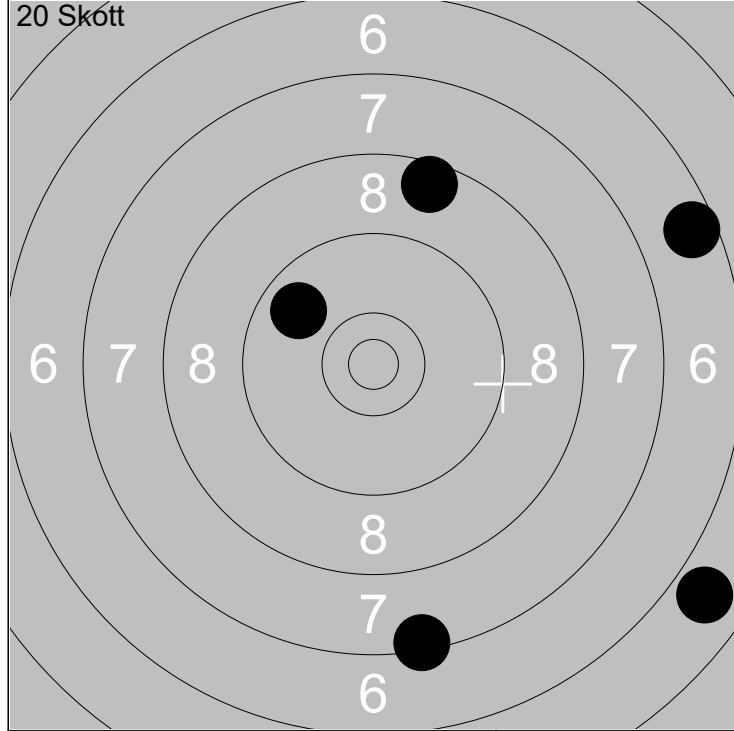

1:	6.6	→
2:	8.6	↑
3:	9.8	↖
4:	7.4	↓
5:	5.9	↘

Serie	35 (0x)
Total	35 (0x)

6:	5.0	←
7:	7.3	←
8:	8.0	↓
9:	3.7	←
10:	7.5	→

Serie	30 (0x)
Total	65 (0x)

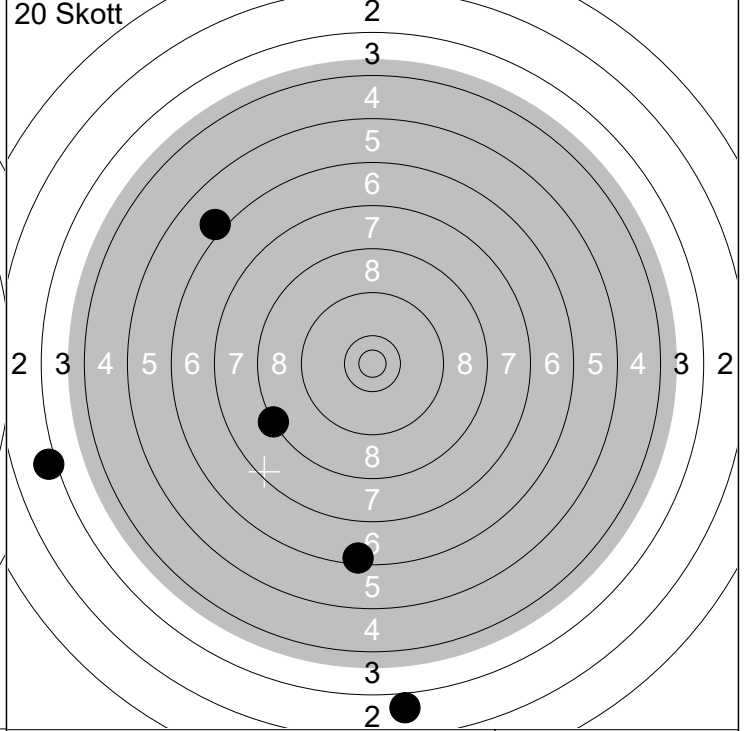
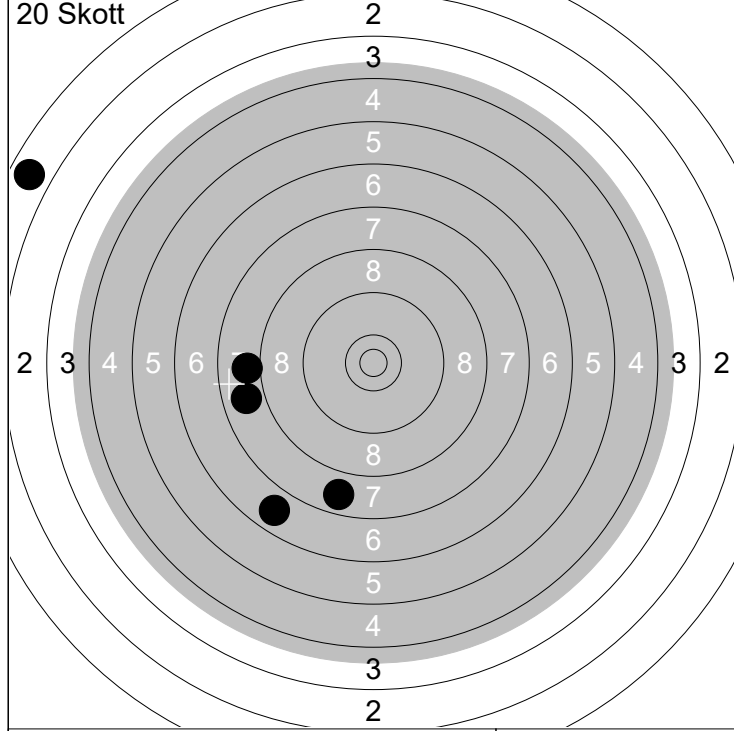

11:	6.8	↘
12:	1.8	↖
13:	8.0	←
14:	7.8	↓
15:	7.9	←

Serie	29 (0x)
Total	94 (0x)

16:	8.3	←
17:	6.1	↖
18:	3.0	↓
19:	6.5	↓
20:	3.1	←

Serie	26 (0x)
Total	120 (0x)

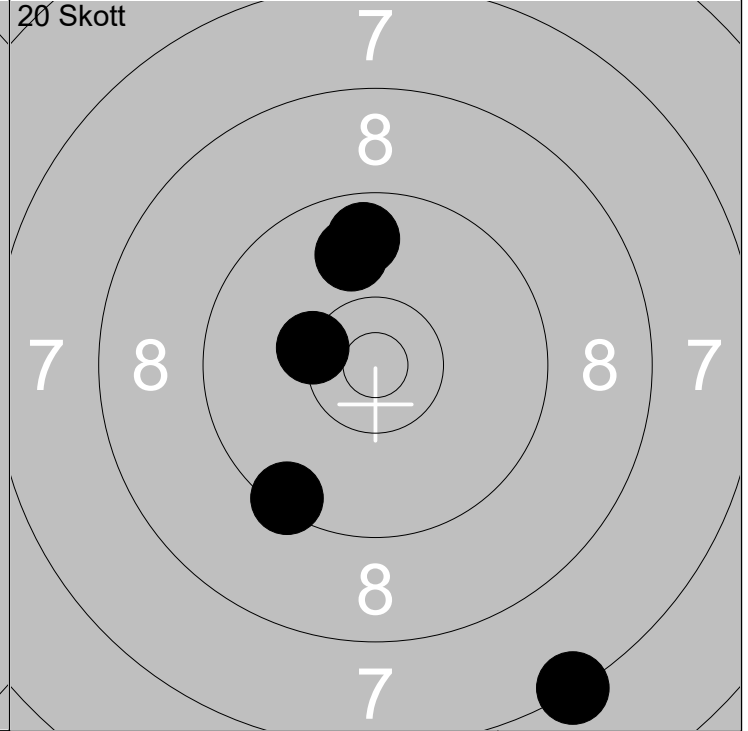
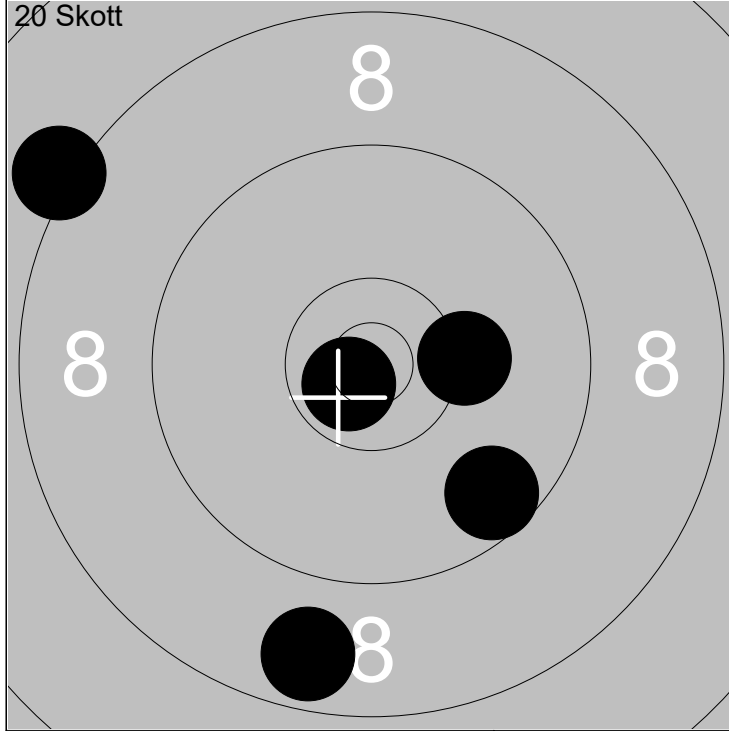

1: 10.7x ↙	Serie 45 ( 1x)
2: 9.6 ↘	
3: 10.2 →	
4: 8.7 ↓	
5: 8.2 ↖	
Total 45 ( 1x)	

6: 9.4 ↙	Serie 44 ( 1x)
7: 10.3x ↖	
8: 9.7 ↑	
9: 9.9 ↑	
10: 7.3 ↘	
Total 89 ( 2x)	

6: 9.4 ↙	Serie 44 ( 1x)
7: 10.3x ↖	
8: 9.7 ↑	
9: 9.9 ↑	
10: 7.3 ↘	
Total 89 ( 2x)	

6: 9.4 ↙	Serie 44 ( 1x)
7: 10.3x ↖	
8: 9.7 ↑	
9: 9.9 ↑	
10: 7.3 ↘	
Total 89 ( 2x)	

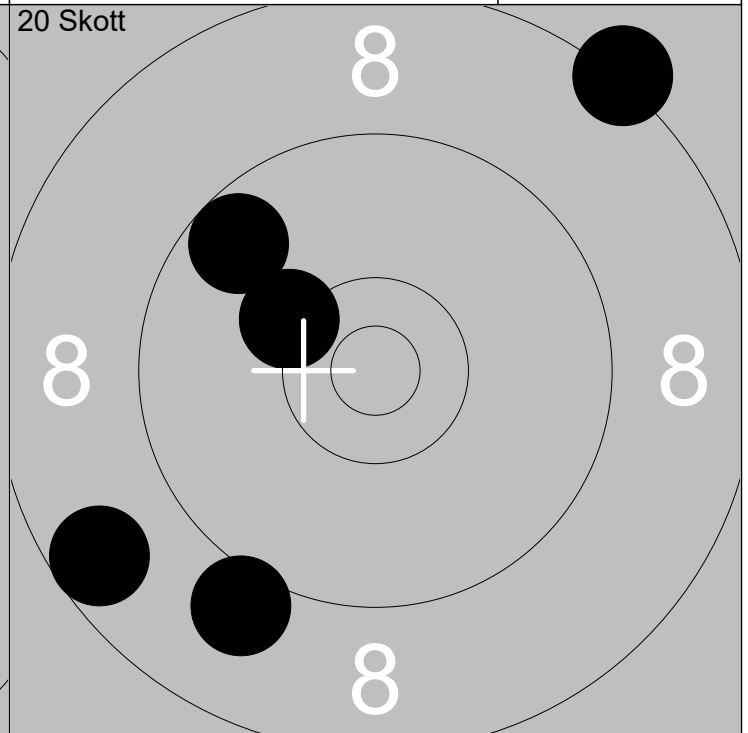
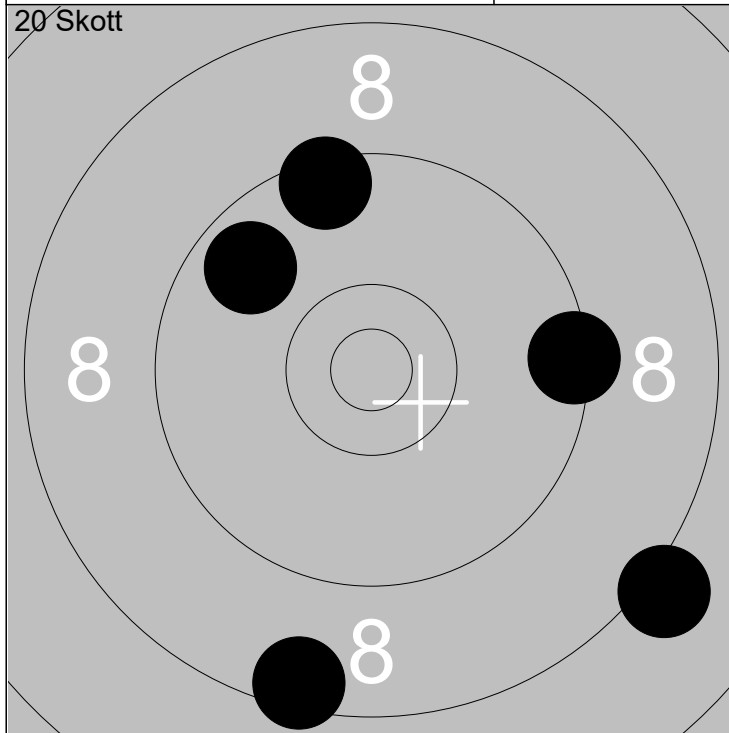

11: 9.7 ↖	Serie 43 ( 0x)
12: 8.2 ↘	
13: 9.4 →	
14: 8.5 ↓	
15: 9.5 ↑	
Total 132 ( 2x)	

16: 9.6 ↖	Serie 44 ( 0x)
17: 9.1 ↓	
18: 10.3 ↖	
19: 8.6 ↙	
20: 8.3 ↗	
Total 176 ( 2x)	

16: 9.6 ↖	Serie 44 ( 0x)
17: 9.1 ↓	
18: 10.3 ↖	
19: 8.6 ↙	
20: 8.3 ↗	
Total 176 ( 2x)	

16: 9.6 ↖	Serie 44 ( 0x)
17: 9.1 ↓	
18: 10.3 ↖	
19: 8.6 ↙	
20: 8.3 ↗	
Total 176 ( 2x)	

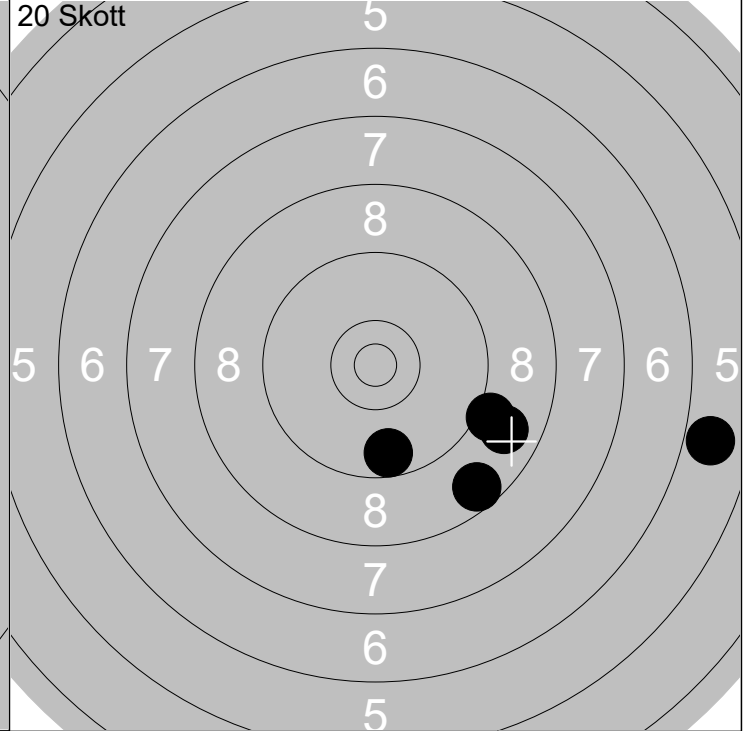
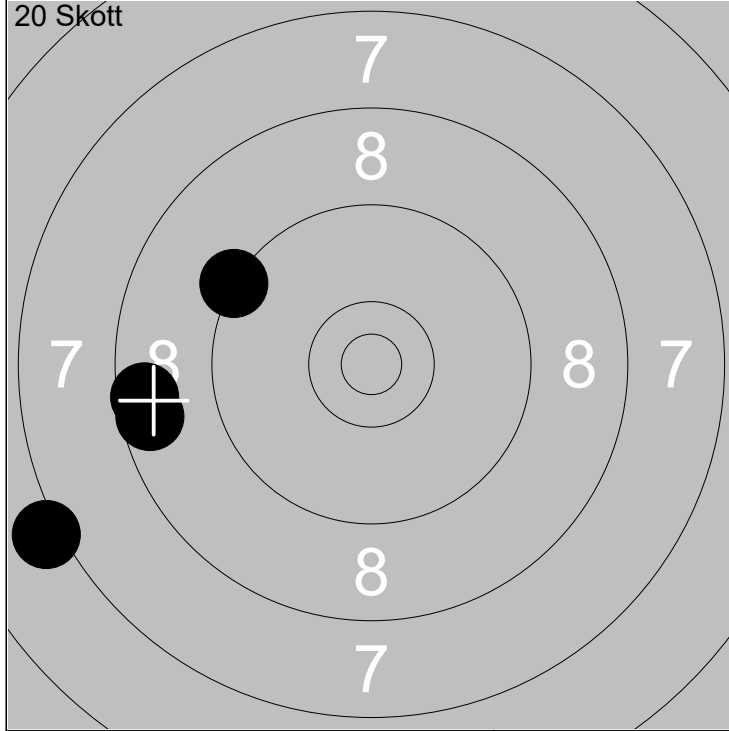

1: 8.6 ←	Serie	38 ( 0x)
2: 8.6 ←		
3: 6.0	Total	38 ( 0x)
4: 7.2 ←		
5: 9.3 ↖		

6: 8.6 ↘	Serie	39 ( 0x)
7: 5.9 →		
8: 9.1 ↘	Total	77 ( 0x)
9: 9.6 ↓		
10: 8.8 ↘		

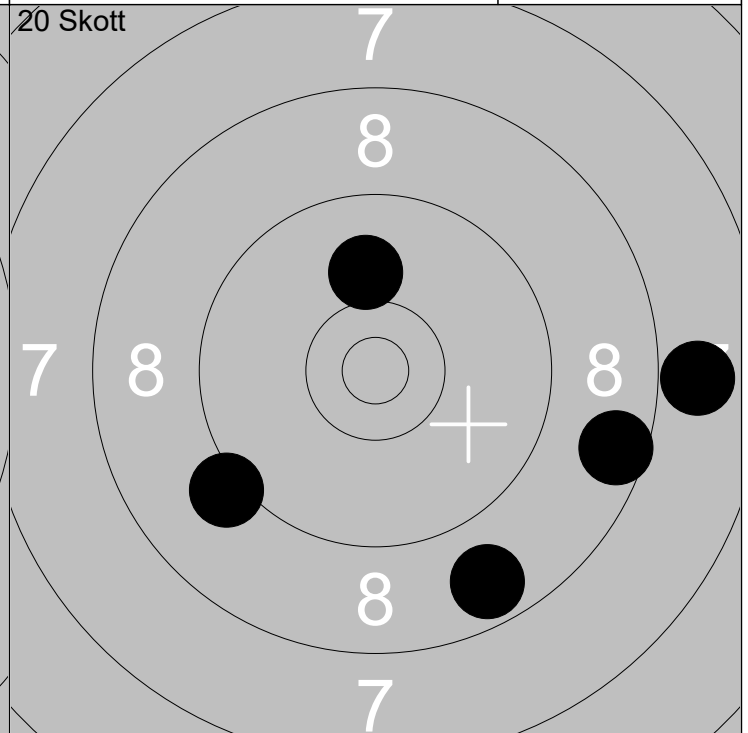
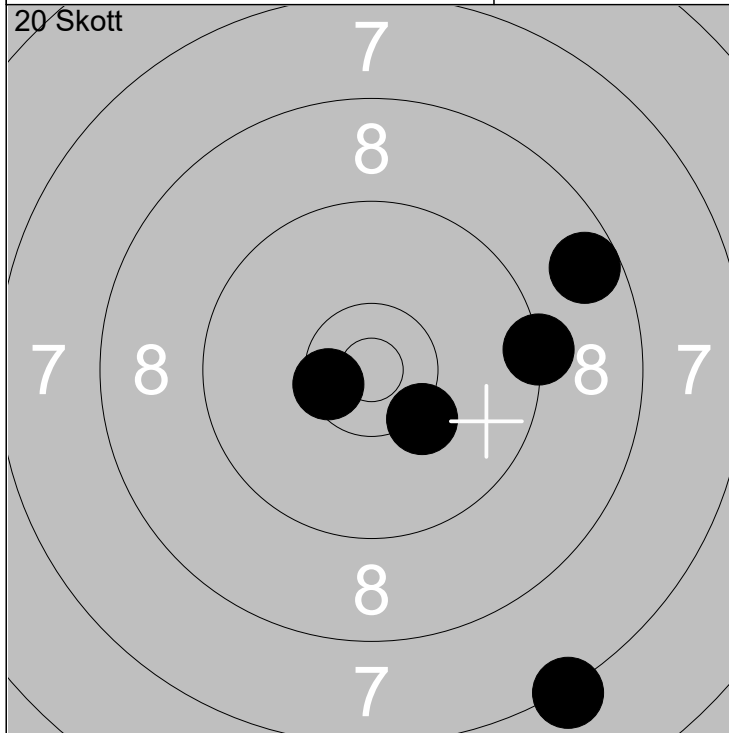

11: 10.3 ↘	Serie	44 ( 1x)
12: 8.6 →		
13: 10.5x ←	Total	121 ( 1x)
14: 9.3 →		
15: 7.3 ↓		

16: 9.2 ←	Serie	42 ( 0x)
17: 10.0 ↑		
18: 7.9 →	Total	163 ( 1x)
19: 8.6 →		
20: 8.7 ↓		

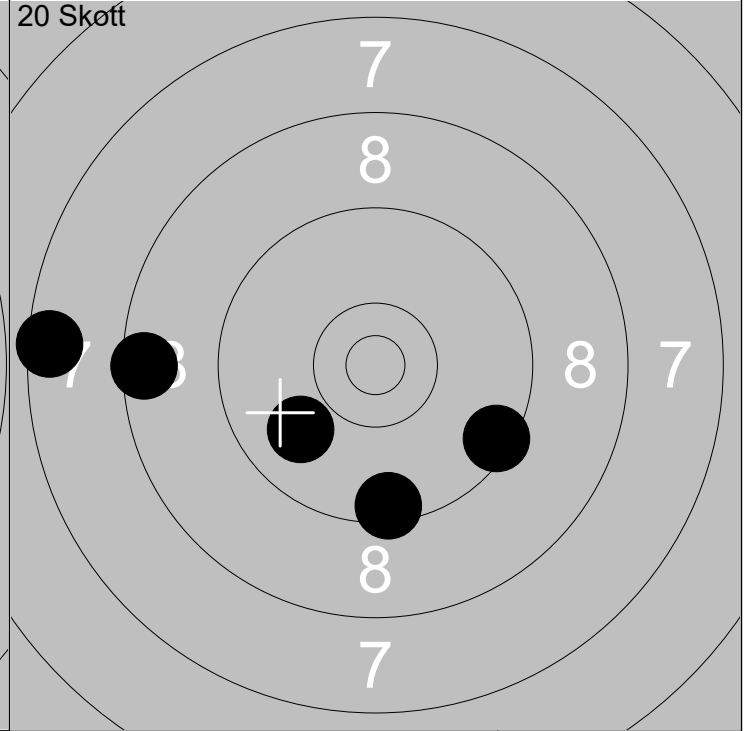
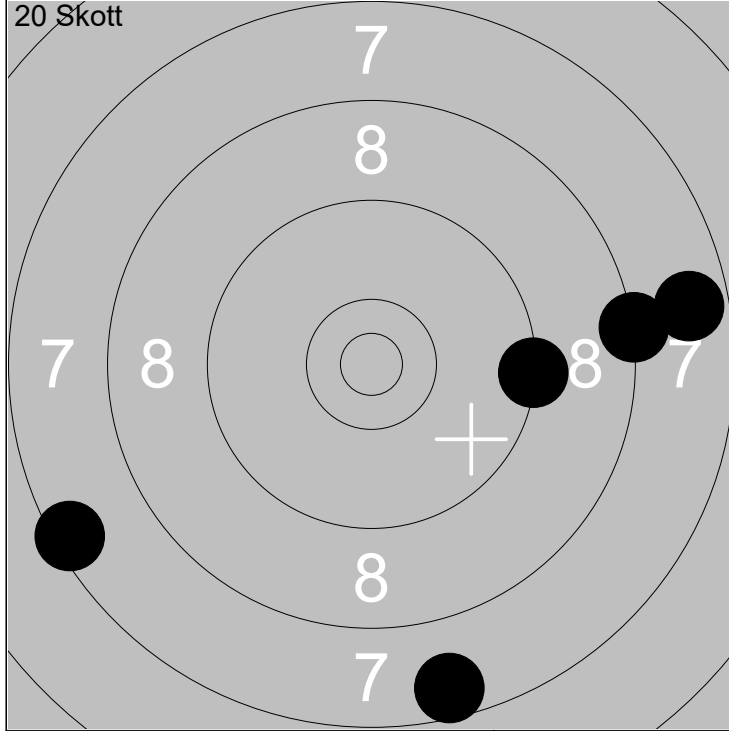

1: 7.6 ↓	2: 7.7 →	3: 8.3 →	4: 9.3 →	5: 7.5 ←	
					Serie 38 (0x)
					Total 38 (0x)

6: 8.5 ←	7: 9.5 ↓	8: 9.5 →	9: 9.9 ←	10: 7.5 ←	
					Serie 42 (0x)
					Total 80 (0x)

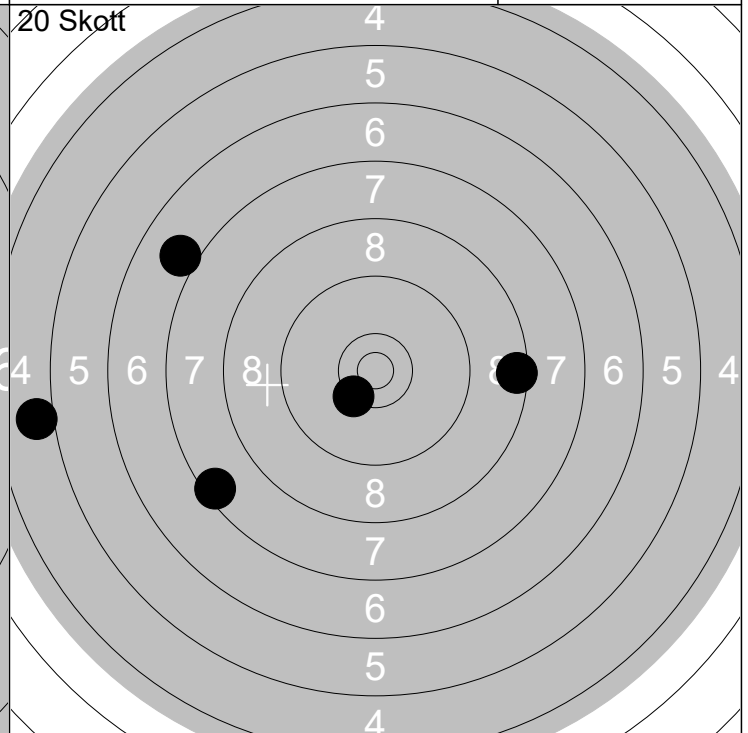
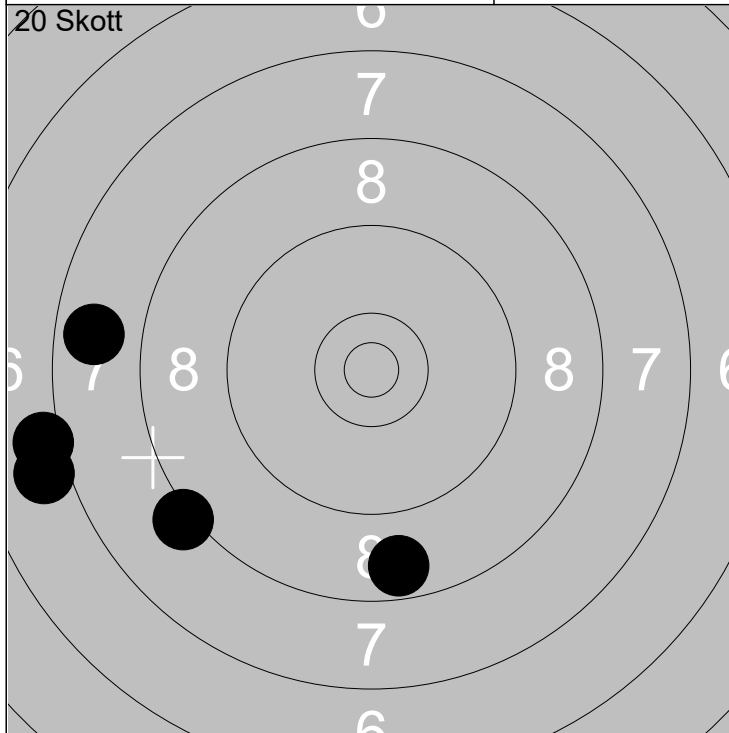

11: 7.1 ←	12: 7.0 ←	13: 8.7 ↓	14: 7.7 ←	15: 8.2 ←	
					Serie 37 (0x)
					Total 117 (0x)

16: 7.5 ←	17: 8.5 →	18: 5.0 ←	19: 10.4x ←	20: 7.0 ←	
					Serie 37 (1x)
					Total 154 (1x)



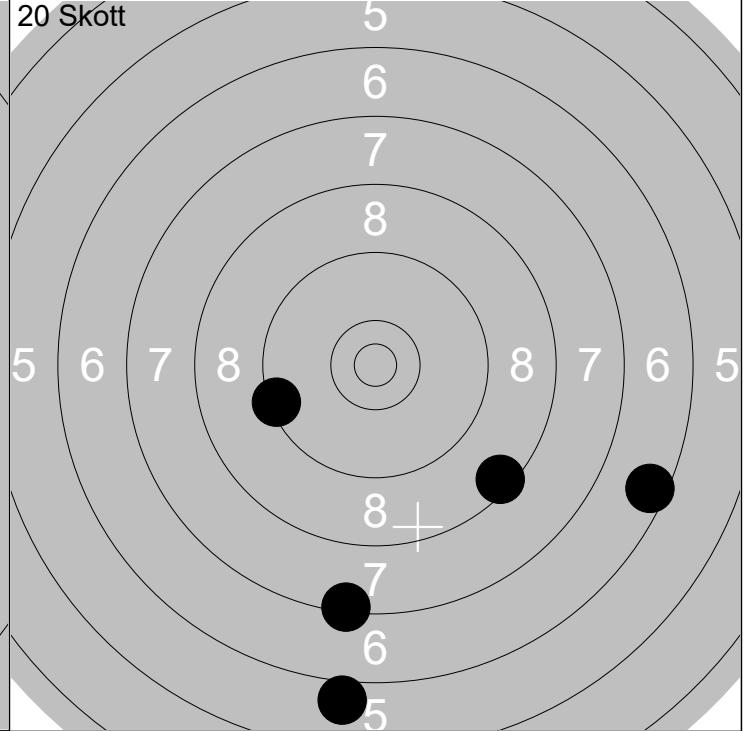
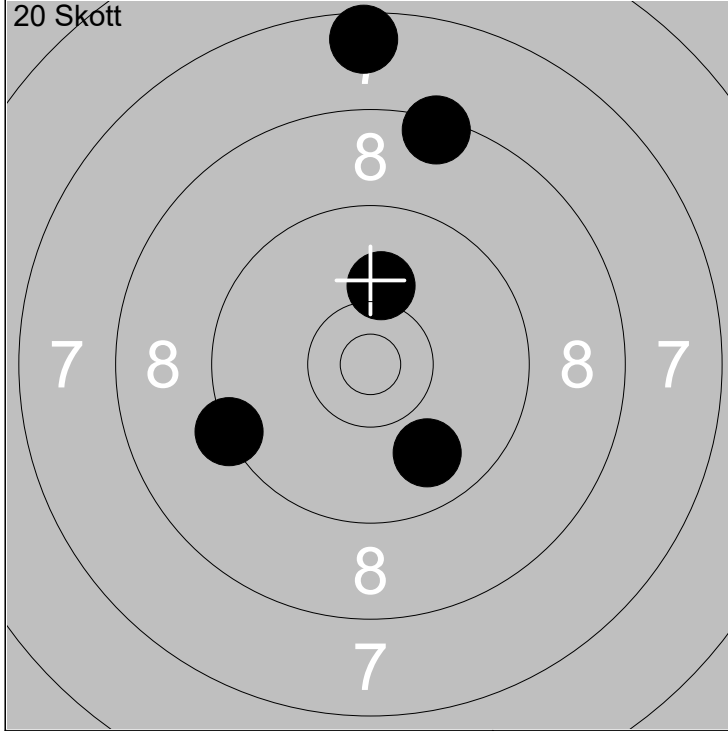

1: 9.3	←
2: 7.6	↑
3: 10.1	↑
4: 8.4	↑
5: 9.9	↓

Serie	43 (0x)
Total	43 (0x)

6: 9.4	←
7: 8.5	↓
8: 7.4	↓
9: 6.5	→
10: 6.0	↓

Serie	36 (0x)
Total	79 (0x)

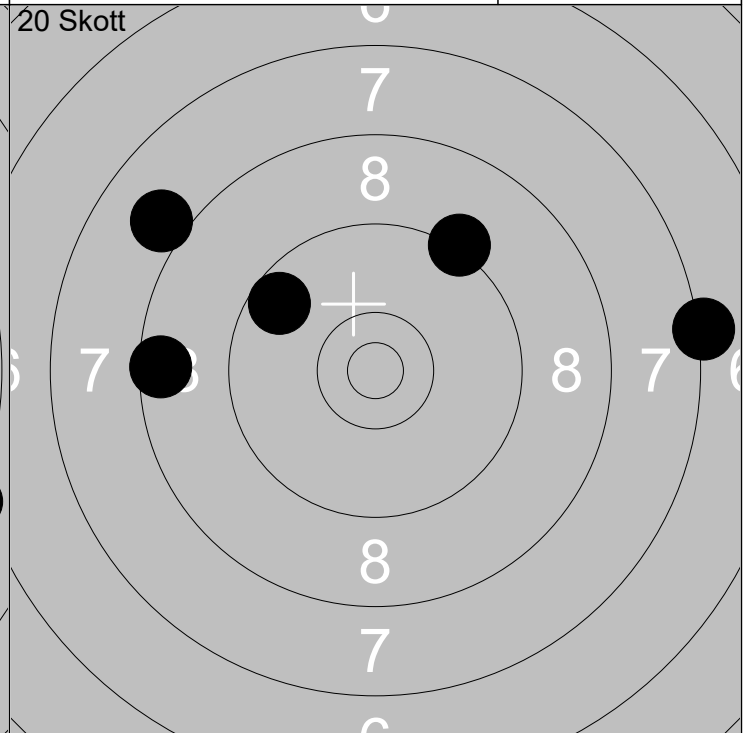
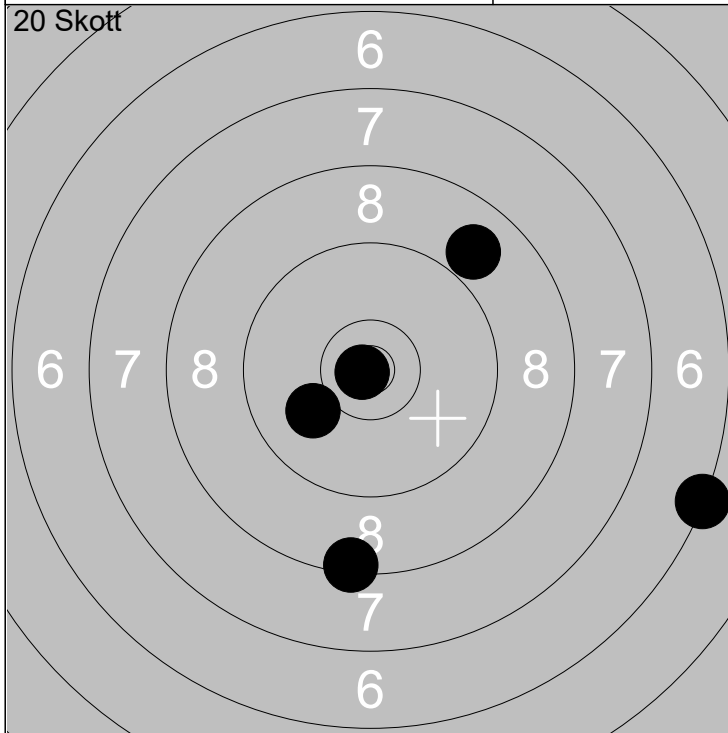

11: 8.4	↓
12: 6.3	→
13: 8.9	↗
14: 10.8x	←
15: 10.0	↙

Serie	42 (1x)
Total	121 (1x)

16: 9.3	↗
17: 9.6	↖
18: 8.5	←
19: 8.0	↖
20: 7.2	→

Serie	41 (0x)
Total	162 (1x)